



# AK5578

## 8-Channel Differential 32-bit $\Delta\Sigma$ ADC

### 1. General Description

The AK557x series is a 32-bit, 768 kHz sampling, differential input A/D converter for digital audio systems. It achieves 121 dB dynamic range and 112 dB S/(N+D) while maintaining low power consumption performance.

The AK5578 integrates a 8-channel A/D converter, suitable for mixers and multi-channel recorders. Four types of digital filters are integrated and selectable according to the sound quality preference. The AK5578 can be easily connected to a DSP by supporting TDM audio formats. Additionally, it supports DSD output up to 11.2MHz. The channel summation improves the dynamic range to 124 dB in 8-to-4 mode, to 127 dB in 8-to-2 mode and to 130 dB in 8-to-1 mode.

### 2. Features

- Sampling Rate: 8 kHz-768 kHz**
- Input: Full Differential Inputs**
- S/(N+D): 112 dB**
- DR: 121 dB (8-to-4 mode: 124 dB, 8-to-2 mode: 127 dB, 8-to-1 mode: 130 dB)**
- S/N: 121 dB (8-to-4 mode: 124 dB, 8-to-2 mode: 127 dB, 8-to-1 mode: 130 dB)**
- Internal Filter: Four types of LPF, Digital HPF**
- Power Supply: 4.75-5.25 V (Analog), 1.7-1.98 V or 3.0-3.6 V (Digital)**
- Output Format:**
  - PCM mode: 24/32-bit MSB justified, I<sup>2</sup>S or TDM**
  - DSD mode: DSD Native 64, 128, 256**
  - Maximized Slot Efficiency in TDM Mode by Optimal Data Placed Mode**
- Cascade TDM I/F:**
  - TDM512: fs= 48 kHz**
  - TDM256: fs= 96 kHz or 48 kHz**
  - TDM128: fs= 192 kHz, 96 kHz or 48 kHz**
- Operation Mode: Master Mode & Slave Mode**
- Detection Function: Input Overflow Flag**
- Serial Interface: 3-wire Serial and I<sup>2</sup>C  $\mu$ P I/F (Pin setting is also available)**
- Power Consumption: 536 mW (@AVDD= 5.0 V, TVDD= 3.3 V, fs= 48 kHz)**
- Package: 64-pin QFN**

<b>3. Table of Contents</b>
-----------------------------

1. General Description .....	1
2. Features .....	1
3. Table of Contents .....	2
4. Block Diagram .....	3
■ Block Diagram .....	3
5. Pin Configurations and Functions .....	4
■ Pin Configurations .....	4
■ Pin Functions .....	5
■ Handling of Unused Pin .....	7
6. Absolute Maximum Ratings .....	8
7. Recommended Operation Conditions .....	8
8. Analog Characteristics .....	9
9. Filter Characteristics .....	10
■ ADC Filter Characteristics (fs= 48 kHz) .....	10
■ ADC Filter Characteristics (fs= 96 kHz) .....	12
■ ADC Filter Characteristics (fs= 192 kHz) .....	14
■ ADC Filter Characteristics (fs= 384 kHz) .....	16
■ ADC Filter Characteristics (fs= 768 kHz) .....	17
10. DC Characteristics .....	18
11. Switching Characteristics .....	19
■ Timing Diagram .....	26
12. Functional Descriptions .....	31
■ Digital Core Power Supply .....	31
■ Output Mode .....	31
■ Master Mode and Slave Mode .....	31
■ System Clock .....	31
■ Audio Interface Format .....	34
■ Channel Summation (PCM mode, DSD mode) .....	46
■ Optimal Data Placement (PCM mode, DSD mode) .....	46
■ CH Power Down & Channel Summation Setting (PCM mode, DSD mode) .....	47
■ Digital HPF (PCM mode) .....	53
■ Overflow Detection (PCM mode, DSD mode) .....	53
■ LDO .....	54
■ Reset .....	54
■ Power Up/Down Sequence .....	55
■ Operation Mode Control .....	58
■ Register Control Interface .....	58
■ Register Map .....	62
■ Register Definitions .....	62
13. Recommended External Circuits .....	65
14. Package .....	68
■ Outline Dimensions .....	68
■ Material & Lead Finish .....	68
■ Marking .....	68
15. Ordering Guide .....	69
16. Revision History .....	69
IMPORTANT NOTICE .....	70

4. Block Diagram

■ Block Diagram

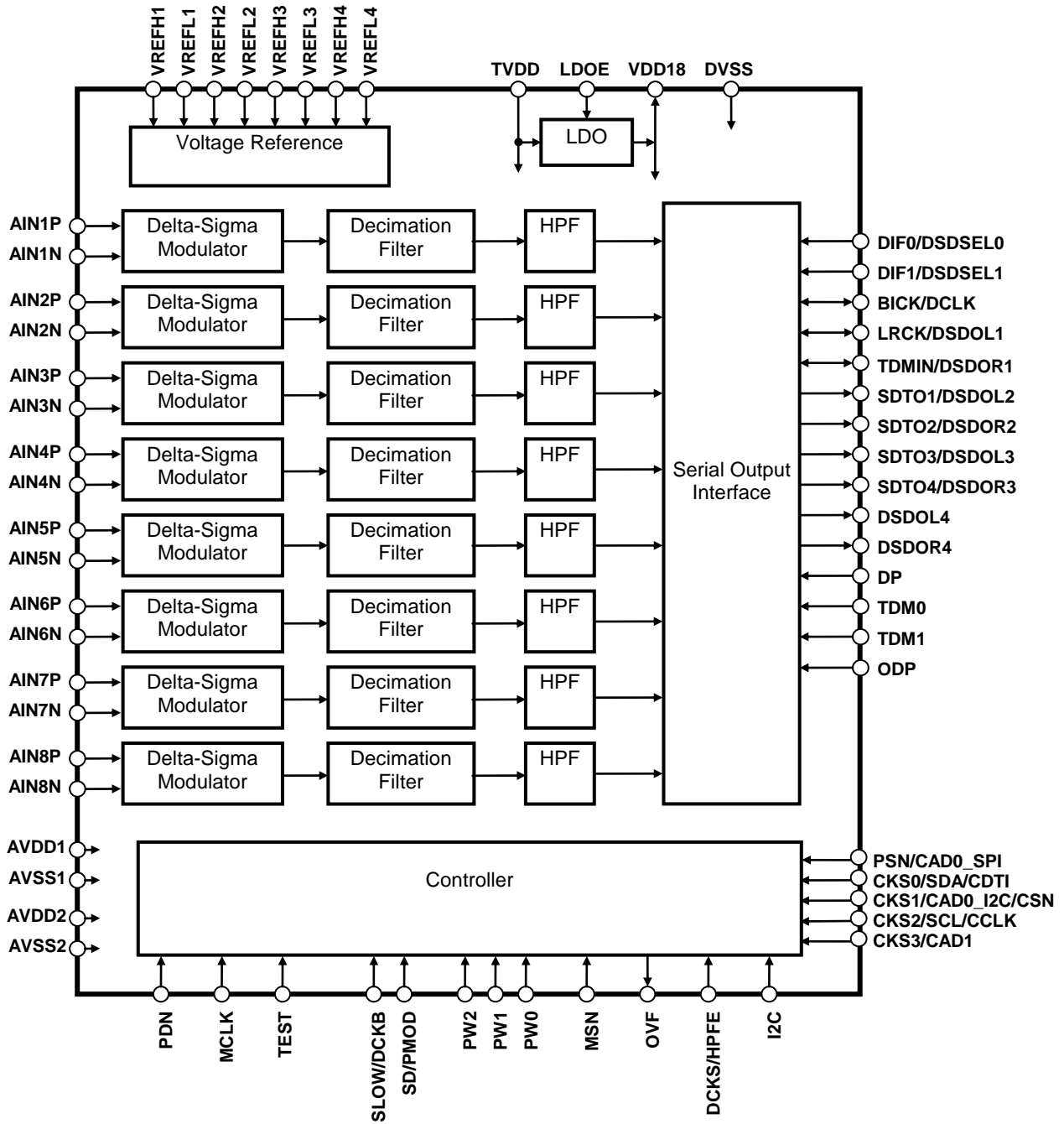
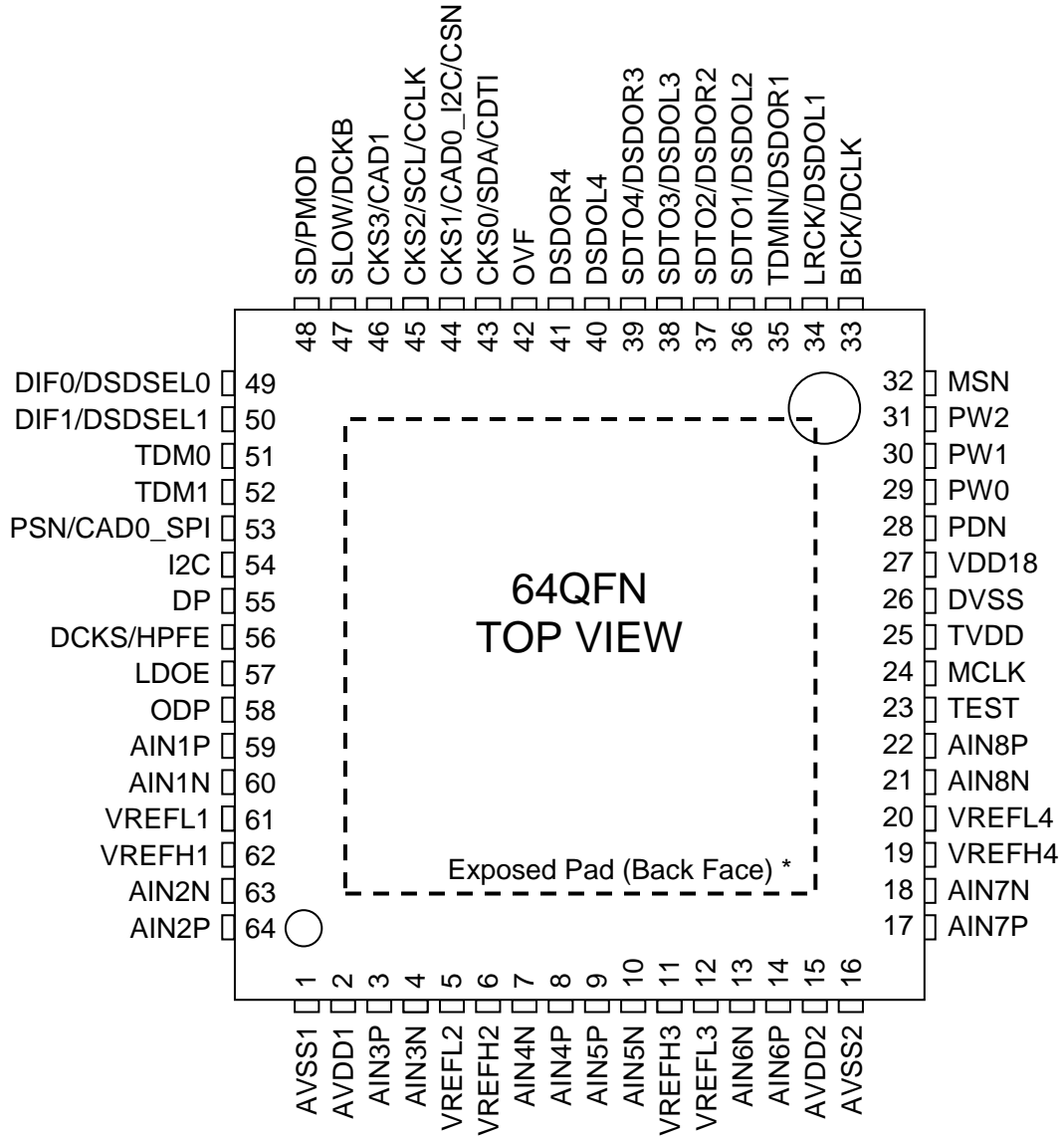

Figure 1. Block Diagram

**5. Pin Configurations and Functions**

■ Pin Configurations



\* The exposed pad at back face of the package must be open or connected to the ground of the board.

Figure 2. Pin Configurations

### ■ Pin Functions

No.	Pin Name	I/O	Function	Power Down Status
1	AVSS1	-	Analog Ground Pin(AIN1-4)	-
2	AVDD1	-	Analog Power Supply Pin(AIN1-4), 4.75-5.25 V	-
3	AIN3P	I	Channel 3 Positive Input Pin	-
4	AIN3N	I	Channel 3 Negative Input Pin	-
5	VREFL2	I	ADC Low Level Voltage Reference Input Pin	-
6	VREFH2	I	ADC High Level Voltage Reference Input Pin	-
7	AIN4N	I	Channel 4 Negative Input Pin	-
8	AIN4P	I	Channel 4 Positive Input Pin	-
9	AIN5P	I	Channel 5 Positive Input Pin	-
10	AIN5N	I	Channel 5 Negative Input Pin	-
11	VREFH3	I	ADC High Level Voltage Reference Input Pin	-
12	VREFL3	I	ADC Low Level Voltage Reference Input Pin	-
13	AIN6N	I	Channel 6 Negative Input Pin	-
14	AIN6P	I	Channel 6 Positive Input Pin	-
15	AVDD2	-	Analog Power Supply Pin(AIN5-8), 4.75-5.25 V	-
16	AVSS2	-	Analog Ground Pin(AIN5-8)	-
17	AIN7P	I	Channel 7 Positive Input Pin	-
18	AIN7N	I	Channel 7 Negative Input Pin	-
19	VREFH4	I	ADC High Level Voltage Reference Input Pin	-
20	VREFL4	I	ADC Low Level Voltage Reference Input Pin	-
21	AIN8N	I	Channel 8 Negative Input Pin	-
22	AIN8P	I	Channel 8 Positive Input Pin	-
23	TEST	I	TEST Enable Pin. This pin is pull down by 100kΩ internally	-
24	MCLK	I	Master Clock Input Pin	-
25	TVDD	-	Digital I/O Buffers and LDO Power Supply Pin 1.7-1.98 V (LDOE pin= "L") or 3.0-3.6 V (LDOE pin= "H").	-
26	DVSS	-	Digital Ground Pin	-
27	VDD18	I	Digital Core Power Supply Pin, 1.7-1.98 V (LDOE pin= "L")	-
		O	LDO Stabilization Capacitor Connect Pin. (LDOE pin= "H")	Hi-z & Pull Down with 500 Ω
28	PDN	I	Reset & Power Down Pin "L": Reset & Power down, "H" : Normal operation	-
29	PW0	I	Power Management Pin, Channel Summation select Pin	-
30	PW1	I	Power Management Pin, Channel Summation select Pin	-
31	PW2	I	Power Management Pin, Channel Summation select Pin	-
32	MSN	I	Master/Slave Select Pin "L": Slave Mode, "H" : Master Mode	-
33	BICK	I	Audio Serial Data Clock Input Pin in PCM & Slave Mode. This pin is pulled down by 100 kΩ internally	-
		O	Audio Serial Data Clock Output Pin in PCM & Master Mode This pin is pulled down by 100 kΩ internally	Hi-z
	DCLK	O	DSD Clock Output Pin in DSD Mode This pin is pulled down by 100 kΩ internally	Hi-z
34	LRCK	I	Channel Clock Input Pin in PCM & Slave Mode This pin is pulled down by 100 kΩ internally	-
		O	Channel Clock Output Pin in PCM & Master Mode This pin is pulled down by 100 kΩ internally	Hi-z
	DSDOL1	O	Audio Serial Data Output Pin for AIN1 in DSD Mode This pin is pulled down by 100 kΩ internally	Hi-z

No.	Pin Name	I/O	Function	Power Down Status
35	TDMIN	I	TDM Data Input Pin in PCM Mode This pin is pulled down by 100 kΩ internally	-
	DSDOR1	O	Audio Serial Data Output Pin for AIN2 in DSD Mode This pin is pulled down by 100 kΩ internally	Hi-z
36	SDTO1	O	Audio Serial Data Output Pin for AIN1 and AIN2 in PCM Mode	L
	DSDOL2	O	Audio Serial Data Output Pin for AIN3 in DSD Mode	L
37	SDTO2	O	Audio Serial Data Output Pin for AIN3 and AIN4 in PCM Mode	L
	DSDOR2	O	Audio Serial Data Output Pin for AIN4 in DSD Mode	L
38	SDTO3	O	Audio Serial Data Output Pin for AIN5 and AIN6 in PCM Mode	L
	DSDOL3	O	Audio Serial Data Output Pin for AIN5 in DSD Mode	L
39	SDTO4	O	Audio Serial Data Output Pin for AIN7 and AIN8 in PCM Mode	L
	DSDOR3	O	Audio Serial Data Output Pin for AIN6 in DSD Mode	L
40	DSDOL4	O	Audio Serial Data Output Pin for AIN7 in DSD Mode	L
41	DSDOR4	O	Audio Serial Data Output Pin for AIN8 in DSD Mode	L
42	OVF	O	Analog Input Over Flow Flag Output Pin	L
43	CKS0	I	Clock Mode Select Pin	-
	SDA	I/O	Control Data I/O Pin in I2C Bus Serial Control Mode	Hi-z
	CDTI	I	Control Data Input Pin in 3-wire Serial Control Mode	-
44	CKS1	I	Clock Mode Select Pin	-
	CAD0_I2C	I	Chip Address 0 Pin in I2C Bus Serial Control Mode	-
	CSN	I	Chip Select Pin in 3-wire Serial Control Mode	-
45	CKS2	I	Clock Mode Select Pin	-
	SCL	I	Control Data Clock Pin in I2C Bus Serial Control Mode	-
	CCLK	I	Control Data Clock Pin in 3-wire Serial Control Mode	-
46	CKS3	I	Clock Mode Select Pin	-
	CAD1	I	Chip Address 1 Pin in I2C Bus or 3-wire Serial Control Mode	-
47	SLOW	I	Slow Roll-OFF Digital Filter Select Pin in PCM Mode	-
	DCKB	I	Polarity of DCLK Pin in DSD Mode	-
48	SD	I	Short Delay Digital Filter Select Pin in PCM Mode	-
	PMOD	I	DSD Phase Modulation Mode Select Pin in DSD Mode	-
49	DIF0	I	Audio Data Format Select Pin in PCM Mode “L”: MSB justified, “H”: I2S	-
	DSDSEL0	I	DSD Sampling Rate Control Pin in DSD Mode	-
50	DIF1	I	Audio Data Format Select Pin in PCM Mode “L”: 24-bit Mode, “H”: 32-bit Mode	-
	DSDSEL1	I	DSD Sampling Rate Control Pin in DSD Mode	-
51	TDM0	I	TDM I/F Format Select Pin * This pin must be fixed to “L” when using DSD mode.	-
52	TDM1	I	TDM I/F Format Select Pin * This pin must be fixed to “L” when using DSD mode.	-
53	PSN	I	Control Mode Select Pin (I2C pin = “H”) “L”: I2C Bus Serial Control Mode, “H”: Parallel Control Mode	-
	CAD0_SPI	I	Chip Address 0 Pin in 3-wire Serial Control Mode (I2C pin = “L”)	-
54	I2C	I	Control Mode Select Pin “L”: 3-wire Serial Control Mode “H”: I2C Bus Serial Control Mode or Parallel Control Mode	-
55	DP	I	DSD Mode Enable Pin “L”: PCM Mode, “H”: DSD Mode	-

No.	Pin Name	I/O	Function	Power Down Status
56	HPFE	I	High Pass Filter Enable Pin “L”: HPF Disable, “H”: HPF Enable	-
	DCKS	I	Master Clock Frequency Select at DSD Mode (DSD Only)	
57	LDOE	I	LDO Enable Pin “L”: LDO Disable, “H”: LDO Enable This pin is pulled down by 100 kΩ internally.	-
58	ODP	I	Optimal Data Placement Mode Select Pin	-
59	AIN1P	I	Channel 1 Positive Input Pin	-
60	AIN1N	I	Channel 1 Negative Input Pin	-
61	VREFL1	I	ADC Low Level Voltage Reference Input Pin	-
62	VREFH1	I	ADC High Level Voltage Reference Input Pin	-
63	AIN2N	I	Channel 2 Negative Input Pin	-
64	AIN2P	I	Channel 2 Positive Input Pin	-

Note 1. All digital input pins must not be allowed to float.

### ■ Handling of Unused Pin

The unused I/O pins should be connected appropriately.

#### 1. PCM Mode

Classification	Pin Name	Setting
Analog	AIN1-8P, AIN1-8N	Open
	VREFH1-4	Connect to AVDD
	VREFL1-4	Connect to AVSS
Digital	TDMIN, TEST	Connect to DVSS
	SDTO1-4, DSDOL4, DSDOR4, OVF	Open

#### 2. DSD Mode

Classification	Pin Name	Setting
Analog	AIN1-8P, AIN1-8N	Open
	VREFH1-4	Connect to AVDD
	VREFL1-4	Connect to AVSS
Digital	TDM0, TDM1, TEST	Connect to DVSS
	DSDOL1-4, DSDOR1-4, OVF	Open

Note 2. Unused channels must be powered down.

### 6. Absolute Maximum Ratings

(VSS= 0 V; [Note 3](#))

Parameter		Symbol	Min.	Max.	Unit
Power Supplies:	Analog (AVDD pin)	AVDDam	-0.3	6.0	V
	Digital Interface (TVDD pin)	TVDDam	-0.3	4.0	V
	Digital Core (VDD18 pin) ( <a href="#">Note 4</a> )	VDD18am	-0.3	2.5	V
Input Current (Any Pin Except Supplies)		IIN	-	±10	mA
Analog Input Voltage (AIN1-4P, AIN1-4N pins)		VINA	-0.3	AVDD+0.3	V
Digital Input Voltage		VIND	-0.3	TVDD+0.3	V
Ambient Temperature (Power applied)					°C
When the back tab is connected to VSS		Ta	-40	105	°C
When the back tab is open		Ta	-40	70	°C
Storage Temperature		Tstg	-65	150	°C

Note 3. All voltages with respect to ground.

Note 4. The 1.8 V LDO is off (LDOE pin = "L") and an external power is supplied to the VDD18 pin.

WARNING: Operation at or beyond these limits may result in permanent damage to the device.  
Normal operation is not guaranteed at these extremes.

### 7. Recommended Operation Conditions

(VSS= 0 V; [Note 3](#))

Parameter		Symbol	Min.	Typ.	Max.	Unit
Power Supplies	Analog (AVDD pin)	AVDD	4.75	5.0	5.25	V
	(LDOE pin= "L") ( <a href="#">Note 5</a> )					
	Digital Interface (TVDD pin) ( <a href="#">Note 6</a> )	TVDD	1.7	1.8	1.98	V
	Digital Core (VDD18 pin)	VDD18	1.7	1.8	1.98	V
Voltage Reference	(LDOE pin= "H") ( <a href="#">Note 7</a> )					
	Digital Interface (TVDD pin)	TVDD	3.0	3.3	3.6	V
Voltage Reference	"H" voltage Reference ( <a href="#">Note 8</a> )	VREFH1-4	4.75	5.0	5.25	V
	"L" voltage reference ( <a href="#">Note 9</a> )	VREFL1-4	-	AVSS	-	V

Note 3. All voltages with respect to ground.

Note 5. TVDD pin must be powered up before VDD18 pin when the LDOE pin = "L". The power up sequence between AVDD pin and TVDD pin or between AVDD pin and VDD18 pin is not critical.

Note 6. TVDD must not exceed VDD18±0.1 V when LDOE pin= "L".

Note 7. When LDOE pin = "H", the internal LDO supplies 1.8 V (typ). The power up sequences between AVDD pin and TVDD pin is not critical.

Note 8. VREFH1-4 must not exceed AVDD+0.1 V.

Note 9. VREFL1-4 must be connected to AVSS.

Analog Input Voltage is proportional to {(VREFH) – (VREFL)}.

Vin (typ, @ 0dB) = ±2.8 × {(VREFH) – (VREFL)} / 5 [V].

\* AKM assumes no responsibility for the usage beyond the conditions in this data sheet.



### 8. Analog Characteristics

(Ta= 25 °C; AVDD= 5.0 V; TVDD= 3.3 V, fs= 48 kHz, BICK= 64fs;  
Signal Frequency= 1 kHz; 24-bit Data; Measurement frequency= 20 Hz-20 kHz at fs= 48 kHz,  
40 Hz-40 kHz at fs= 96 kHz, 40 Hz-40 kHz at fs= 192 kHz, unless otherwise specified.)

Parameter	Min.	Typ.	Max.	Unit		
<b>Analog Input Characteristics:</b>						
Resolution	-	-	32	bit		
Input Voltage	(Note 10)			Vpp		
S/(N+D)	fs= 48 kHz BW=20 kHz	-1 dBFS	100	112	-	dB
		-20 dBFS	-	97	-	dB
		-60 dBFS	-	57	-	dB
	fs= 96 kHz BW= 40 kHz	-1 dBFS	-	110	-	dB
		-20 dBFS	-	90	-	dB
		-60 dBFS	-	50	-	dB
	fs= 192 kHz BW= 40 kHz	-1 dBFS	-	110	-	dB
		-20 dBFS	-	90	-	dB
		-60 dBFS	-	50	-	dB
Dynamic Range (-60 dBFS with A-weighted)	Not-Sum. mode		117	121	-	dB
	8-to-4 mode		-	124	-	dB
	8-to-2 mode		-	127	-	dB
	8-to-1 mode		-	130	-	dB
S/N (A-weighted)	Not-Sum. mode		117	121	-	dB
	8-to-4 mode		-	124	-	dB
	8-to-2 mode		-	127	-	dB
	8-to-1 mode		-	130	-	dB
Input Resistance These values will be doubled in DSD 64fs mode. (Values in DSD128 or DSD256 modes are as shown here)	3.0	3.6	4.2	kΩ		
Interchannel Isolation (AIN1↔AIN2, AIN3↔AIN4, AIN5↔AIN6, AIN7↔AIN8)	110	120	-	dB		
Interchannel Gain Mismatch	-	0	0.5	dB		
Power Supply Rejection	-	60	-	dB		
<b>Power Supplies</b>						
Power Supply Current						
Normal Operation (PDN pin = "H", LDOE pin = "H")						
AVDD + VREFHm (m=1-4)	-	96	125	mA		
TVDD (fs= 48 kHz)	-	17	22	mA		
TVDD (fs= 96 kHz)	-	28	36	mA		
TVDD (fs= 192 kHz)	-	25	32	mA		
Power Down mode (PDN pin = "L")	(Note 12)					
AVDD+TVDD	-	10	100	μA		

Note 10. This value is (AINnP)-(AINnN) that the ADC output becomes full-scale (n=1-8).

$V_{in} = 0.56 \times (V_{REFHm} - V_{REFLm})$  [Vpp]. (m=1-4)

Note 11. PSRR is applied to AVDD, TVDD with 1 kHz, 20 mVpp sine wave. The VREFH1-4 are held to the fixed voltage.

Note 12. All digital inputs are fixed to TVDD or TVSS.

## 9. Filter Characteristics

### ■ ADC Filter Characteristics (fs= 48 kHz)

(Ta= -40 - +105°C; AVDD= 4.75-5.25 V, TVDD=1.7-1.98 V (LDOE pin="L") or 3.0-3.6 V (LDOE pin="H"), VDD18= 1.7-1.98 V (LDOE pin= "L"))

Parameter	Symbol	Min.	Typ.	Max.	Unit	
<b>Digital Filter (Decimation LPF): SHARP ROLL-OFF (Figure 3)</b> (SD pin= "L", SLOW pin= "L")						
Passband (Note 13)	+0.001/-0.06 dB	PB	0	-	22.0	kHz
	-6.0 dB		-	24.4	-	kHz
Stopband (Note 13)		SB	27.9	-	-	kHz
Stopband Attenuation		SA	85	-	-	dB
Group Delay Distortion 0 - 20.0 kHz		ΔGD	-	0	-	1/fs
Group Delay (Note 14)		GD	-	19	-	1/fs
<b>Digital Filter (Decimation LPF): SLOW ROLL-OFF (Figure 4)</b> (SD pin= "L", SLOW pin= "H")						
Passband (Note 13)	+0.001/-0.076 dB	PB	0	-	12.5	kHz
	-6.0 dB		-	21.9	-	kHz
Stopband (Note 13)		SB	36.5	-	-	kHz
Stopband Attenuation		SA	85	-	-	dB
Group Delay Distortion 0 - 20.0 kHz		ΔGD	-	0	-	1/fs
Group Delay (Note 14)		GD	-	7	-	1/fs
<b>Digital Filter (Decimation LPF): SHORT DELAY SHARP ROLL-OFF FILTER (Figure 5)</b> (SD pin= "H", SLOW pin= "L")						
Passband (Note 13)	+0.001/-0.06 dB	PB	0	-	22.0	kHz
	-6.0 dB		-	24.4	-	kHz
Stopband (Note 13)		SB	27.9	-	-	kHz
Stopband Attenuation		SA	85	-	-	dB
Group Delay Distortion 0 - 20.0 kHz		ΔGD	-	-	2.8	1/fs
Group Delay (Note 14)		GD	-	5	-	1/fs
<b>Digital Filter (Decimation LPF): SHORT DELAY SLOW ROLL-OFF (Figure 6)</b> (SD pin= "H", SLOW pin= "H")						
Passband (Note 13)	+0.001/-0.076 dB	PB	0	-	12.5	kHz
	-6.0 dB		-	21.9	-	kHz
Stopband (Note 13)		SB	36.5	-	-	kHz
Stopband Attenuation		SA	85	-	-	dB
Group Delay Distortion 0 - 20.0 kHz		ΔGD	-	-	1.2	1/fs
Group Delay (Note 14)		GD	-	5	-	1/fs
<b>Digital Filter (HPF):</b>						
Frequency Response	-3.0 dB	FR	-	1.0	-	Hz
	-0.5 dB		-	2.5	-	Hz
	(Note 13) -0.1 dB		-	6.5	-	Hz

Note 13. The Passband and Stopband Frequencies scale with fs.

For Example, PB (+0.001 dB/-0.06 dB) = 0.46 × fs (SHARP ROLL-OFF).

For Example, PB (+0.001 dB/-0.076 dB) = 0.26 × fs (SLOW ROLL-OFF).

Note 14. The calculated delay time induced by digital filtering. This time is from the input of an analog signal to the L channel MSB output timing of the SDTO. It may have an error of +1[1/fs] at maximum when outputting data via audio interfaces.

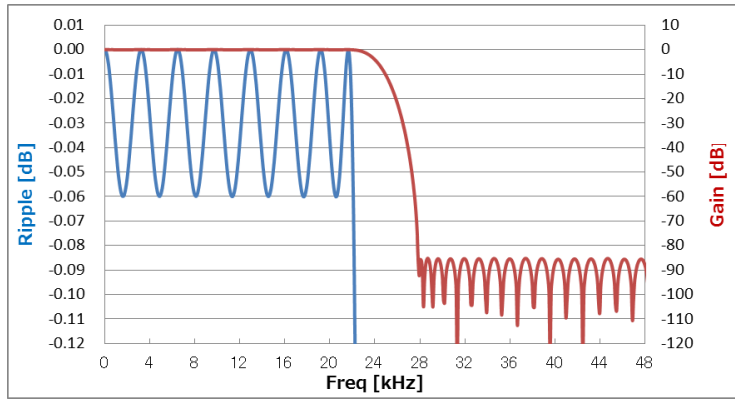

Figure 3. SHARP ROLL-OFF (fs= 48 kHz)

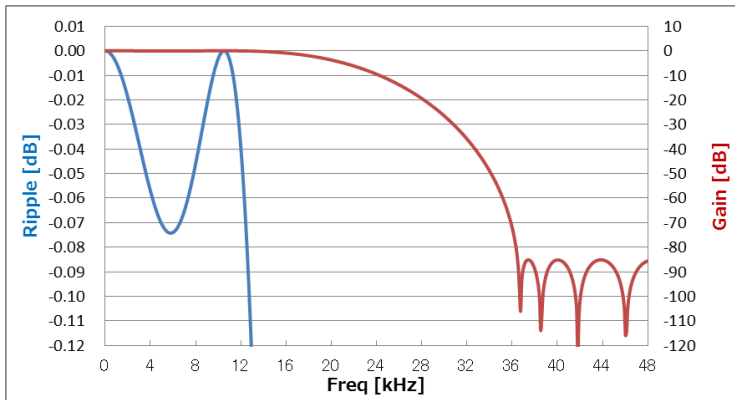

Figure 4. SLOW ROLL-OFF (fs= 48 kHz)

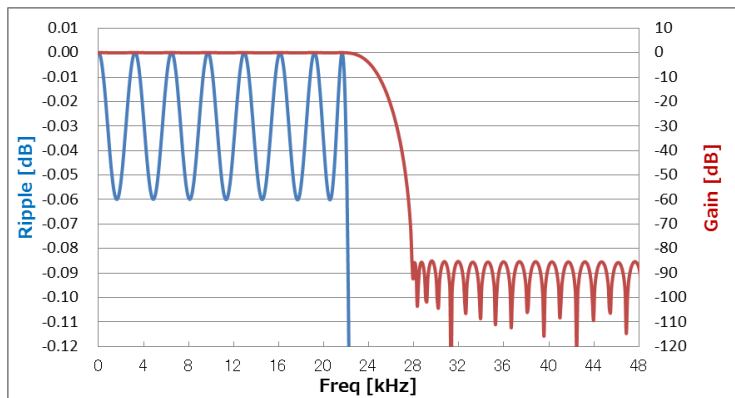

Figure 5. SHORT DELAY SHARP ROLL-OFF (fs= 48 kHz)

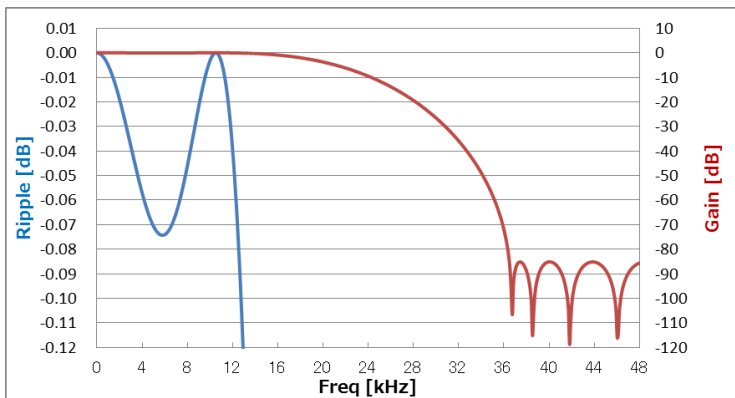

Figure 6. SHORT DELAY SLOW ROLL-OFF (fs= 48 kHz)

### ■ ADC Filter Characteristics (fs= 96 kHz)

(Ta= -40 - +105 °C; AVDD= 4.75-5.25 V, TVDD=1.7-1.98 V (LDOE pin="L") or 3.0-3.6 V (LDOE pin="H"), VDD18= 1.7-1.98 V (LDOE pin= "L"))

Parameter		Symbol	Min.	Typ.	Max.	Unit
<b>Digital Filter (Decimation LPF): SHARP ROLL-OFF (Figure 7)</b> (SD pin= "L", SLOW pin= "L")						
Passband (Note 13)	+0.001/-0.06 dB -6.0 dB	PB	0 -	- 48.8	44.1 -	kHz kHz
Stopband (Note 13)		SB	55.7	-	-	kHz
Stopband Attenuation		SA	85	-	-	dB
Group Delay Distortion 0 - 40.0 kHz		ΔGD	-	0	-	1/fs
Group Delay (Note 14)		GD	-	19	-	1/fs
<b>Digital Filter (Decimation LPF): SLOW ROLL-OFF (Figure 8)</b> (SD pin= "L", SLOW pin= "H")						
Passband (Note 13)	+0.001/-0.076 dB -6.0 dB	PB	0 -	- 43.8	25 -	kHz kHz
Stopband (Note 13)		SB	73	-	-	kHz
Stopband Attenuation		SA	85	-	-	dB
Group Delay Distortion 0 - 40.0 kHz		ΔGD	-	0	-	1/fs
Group Delay (Note 14)		GD	-	7	-	1/fs
<b>Digital Filter (Decimation LPF): SHORT DELAY SHARP ROLL-OFF (Figure 9)</b> (SD pin= "H", SLOW pin= "L")						
Passband (Note 13)	+0.001/-0.06 dB -6.0 dB	PB	0 -	- 48.8	44.1 -	kHz kHz
Stopband (Note 13)		SB	55.7	-	-	kHz
Stopband Attenuation		SA	85	-	-	dB
Group Delay Distortion 0 - 40.0 kHz		ΔGD	-	-	2.8	1/fs
Group Delay (Note 14)		GD	-	5	-	1/fs
<b>Digital Filter (Decimation LPF): SHORT DELAY SLOW ROLL-OFF (Figure 10)</b> (SD pin= "H", SLOW pin= "H")						
Passband (Note 13)	+0.001/-0.076 dB -6.0dB	PB	0 -	- 43.8	25 -	kHz kHz
Stopband (Note 13)		SB	73	-	-	kHz
Stopband Attenuation		SA	85	-	-	dB
Group Delay Distortion 0 - 40.0 kHz		ΔGD	-	-	1.2	1/fs
Group Delay (Note 14)		GD	-	5	-	1/fs
<b>Digital Filter (HPF):</b>						
Frequency Response	-3.0 dB -0.5 dB	FR	- -	1.0 2.5	- -	Hz Hz
(Note 13)	-0.1 dB		-	6.5	-	Hz

Note 13. The Passband and Stopband Frequencies scale with fs.

For example, PB (+0.001 dB/-0.06 dB) = 0.46 × fs (SHARP ROLL-OFF).

For example, PB (+0.001 dB/-0.076 dB) = 0.26 × fs (SLOW ROLL-OFF).

Note 14. The calculated delay time induced by digital filtering. This time is from the input of an analog signal to the L channel MSB output timing of the SDTO. It may have an error of +1[1/fs] at maximum when outputting data via audio interfaces.

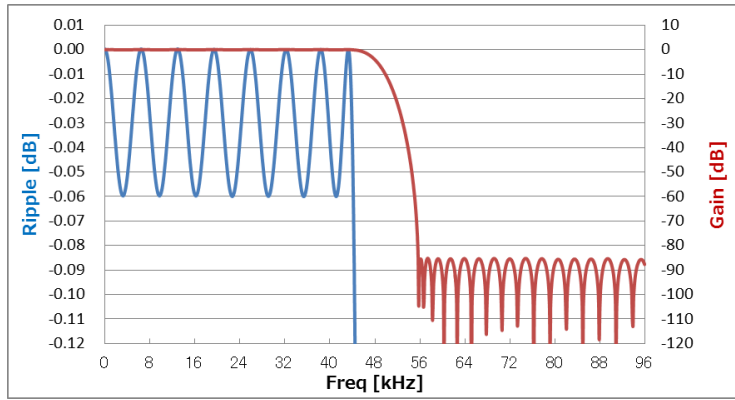

Figure 7. SHARP ROLL-OFF (fs= 96 kHz)

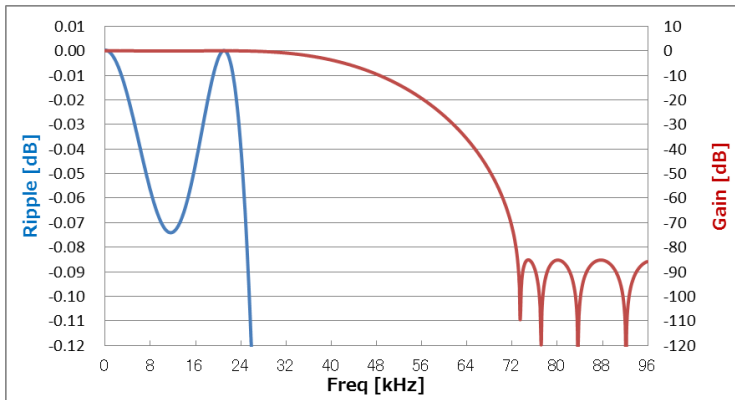

Figure 8. SLOW ROLL-OFF (fs= 96 kHz)

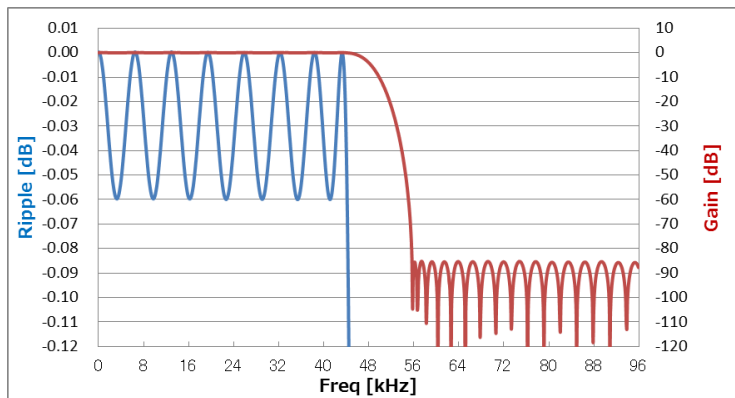

Figure 9. SHORT DELAY SHARP ROLL-OFF (fs= 96 kHz)

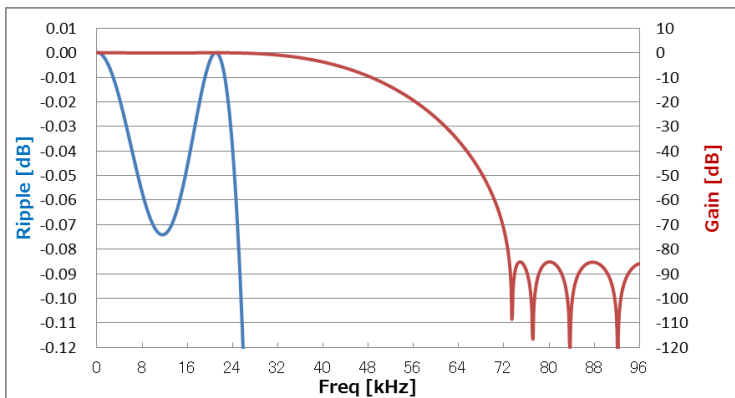

Figure 10. SHORT DELAY SLOW ROLL-OFF (fs= 96 kHz)

### ■ ADC Filter Characteristics (fs= 192 kHz)

(Ta= -40 - +105 °C; AVDD= 4.75-5.25 V, TVDD=1.7-1.98 V (LDOE pin="L") or 3.0-3.6 V (LDOE pin="H"), VDD18= 1.7-1.98 V (LDOE pin= "L"))

Parameter		Symbol	Min.	Typ.	Max.	Unit
<b>Digital Filter (Decimation LPF): SHARP ROLL-OFF (Figure 11)</b> (SD pin="L", SLOW pin= "L")						
Passband (Note 13)	+0.001/-0.037 dB -6.0 dB	PB	0 -	- 100.2	83.7 -	kHz kHz
Stopband (Note 13)		SB	122.9	-	-	kHz
Stopband Attenuation		SA	85	-	-	dB
Group Delay Distortion 0 - 40.0 kHz		ΔGD	-	0	-	1/fs
Group Delay (Note 14)		GD	-	15	-	1/fs
<b>Digital Filter (Decimation LPF): SLOW ROLL-OFF (Figure 12)</b> (SD pin="L", SLOW pin= "H")						
Passband (Note 13)	+0.001/-0.1 dB -6.0 dB	PB	0 -	- 75.2	31.5 -	kHz kHz
Stopband (Note 13)		SB	146	-	-	kHz
Stopband Attenuation		SA	85	-	-	dB
Group Delay Distortion 0 - 40.0 kHz		ΔGD	-	0	-	1/fs
Group Delay (Note 14)		GD	-	8	-	1/fs
<b>Digital Filter (Decimation LPF): SHORT DELAY SHARP ROLL-OFF FILTER (Figure 13)</b> (SD pin="H", SLOW pin= "L")						
Passband (Note 13)	+0.001/-0.037 dB -6.0 dB	PB	0 -	- 100.2	83.7 -	kHz kHz
Stopband (Note 13)		SB	122.9	-	-	kHz
Stopband Attenuation		SA	85	-	-	dB
Group Delay Distortion 0 - 40.0 kHz		ΔGD	-	-	0.3	1/fs
Group Delay (Note 14)		GD	-	6	-	1/fs
<b>Digital Filter (Decimation LPF): SHORT DELAY SLOW ROLL-OFF FILTER (Figure 14)</b> (SD pin="H", SLOW pin= "H")						
Passband (Note 13)	+0.001/-0.1 dB -6.0 dB	PB	0 -	- 75.2	31.5 -	kHz kHz
Stopband (Note 13)		SB	146	-	-	kHz
Stopband Attenuation		SA	85	-	-	dB
Group Delay Distortion 0 - 40.0 kHz		ΔGD	-	-	0.4	1/fs
Group Delay (Note 14)		GD	-	6	-	1/fs
<b>Digital Filter (HPF):</b>						
Frequency Response	-3.0 dB	FR	-	1.0	-	Hz
	-0.5 dB		-	2.5	-	Hz
(Note 13)	-0.1 dB		-	6.5	-	Hz

Note 13. The Passband and Stopband Frequencies scale with fs.

For Example, PB (+0.001 dB/-0.037 dB) = 0.436 × fs (SHARP ROLL-OFF).

For Example, PB (+0.001 dB/-0.1 dB) = 0.164 × fs (SLOW ROLL-OFF).

Note 14. The calculated delay time induced by digital filtering. This time is from the input of an analog signal to the L channel MSB output timing of the SDTO. It may have an error of +1[1/fs] at maximum when outputting data via audio interfaces.

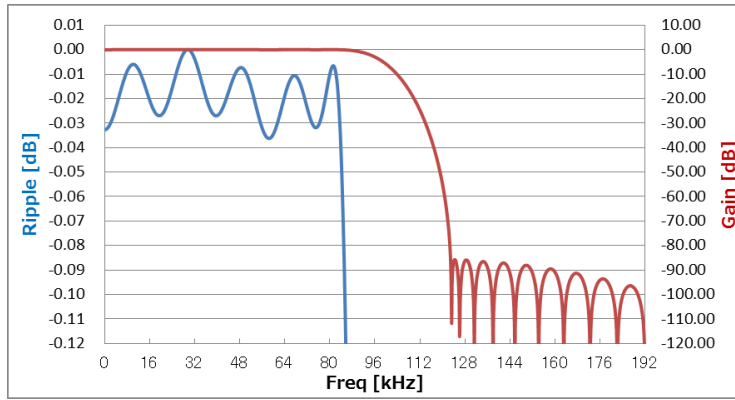

Figure 11. SHARP ROLL-OFF (fs= 192 kHz)

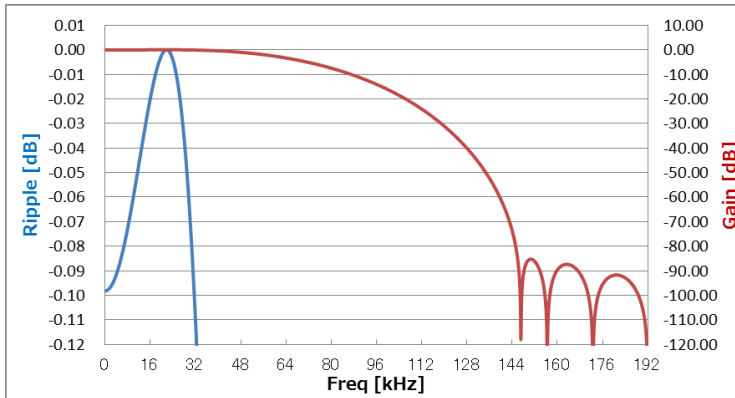

Figure 12. SLOW ROLL-OFF (fs= 192 kHz)

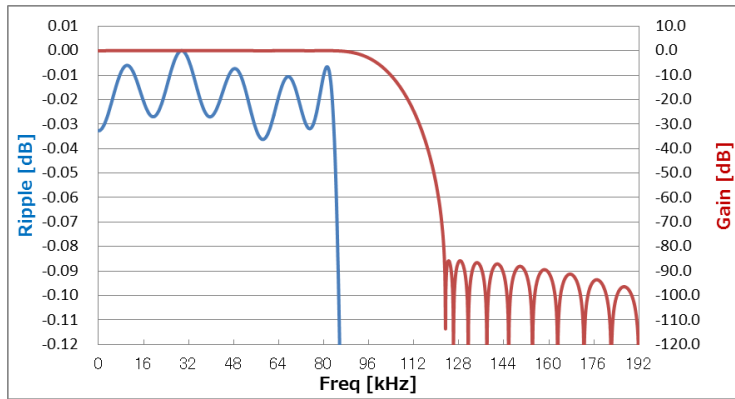

Figure 13. SHORT DELAY SHARP ROLL-OFF (fs= 192 kHz)

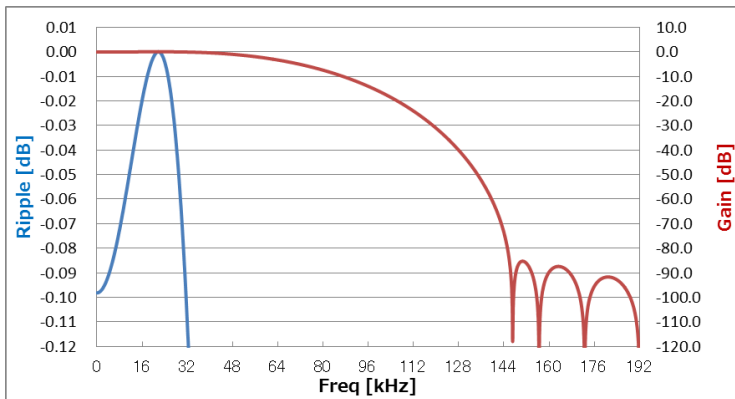

Figure 14. SHORT DELAY SLOW ROLL-OFF (fs= 192 kHz)

■ ADC Filter Characteristics (fs= 384 kHz)

(Ta= -40 - +105 °C; AVDD= 4.75-5.25 V, TVDD=1.7-1.98 V (LDOE pin="L") or 3.0-3.6 V (LDOE pin="H"), VDD18= 1.7-1.98 V (LDOE pin= "L"))

Parameter	Symbol	Min.	Typ.	Max.	Unit
<b>Digital Filter (Decimation LPF) (Figure 15)</b> (SD pin = "X", SLOW pin = "X") * It does not depend on the SD pin and Slow pin.					
Frequency Response (Note 13)	-0.1 dB	-	81.75	-	kHz
	-1.0 dB	-	114	-	kHz
	-3.0 dB	-	137.63	-	kHz
	-6.0 dB	-	157.2	-	kHz
Stopband (Note 13)	SB	277.4	-	-	kHz
Stopband Attenuation	SA	85	-	-	dB
Group Delay Distortion 0 - 40.0 kHz	ΔGD	-	0	-	1/fs
Group Delay (Note 14)	GD	-	7	-	1/fs

Note 13. The Passband and Stopband Frequencies scale with fs.

Note 14. The calculated delay time induced by digital filtering. This time is from the input of an analog signal to the L channel MSB output timing of the SDTO. It may have an error of +1[1/fs] at maximum when outputting data via audio interfaces.

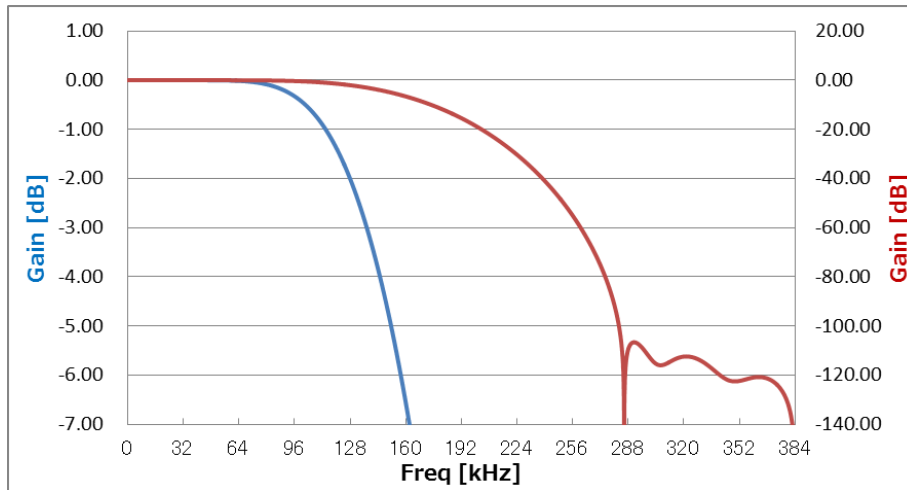

Figure 15. Frequency Response (fs= 384 kHz)



### ■ ADC Filter Characteristics (fs= 768 kHz)

(Ta= -40 - +105 °C; AVDD= 4.75-5.25 V, TVDD=1.7-1.98 V (LDOE pin="L") or 3.0-3.6 V (LDOE pin="H"), VDD18= 1.7-1.98 V (LDOE pin="L"))

Parameter	Symbol	Min.	Typ.	Max.	Unit
<b>Digital Filter (Decimation LPF) (Figure 16)</b> (SD pin = "X", SLOW pin = "X") * It does not depend on the SD pin and SLOW pin.					
Frequency Response (Note 13)	-0.1 dB		26.25		kHz
	-1.0 dB	FR	83.75		kHz
	-3.0 dB		144.5		kHz
	-6.0 dB		203.1		kHz
Stopband (Note 13)	SB	640.3	-	-	kHz
Stopband Attenuation	SA	85	-	-	dB
Group Delay Distortion 0 - 40.0 kHz	$\Delta$ GD	-	0	-	1/fs
Group Delay (Note 14)	GD	-	5	-	1/fs

Note 13. The Passband and Stopband Frequencies scale with fs.

Note 14. The calculated delay time induced by digital filtering. This time is from the input of an analog signal to the L channel MSB output timing of the SDTO. It may have an error of +1[1/fs] at maximum when outputting data via audio interfaces.

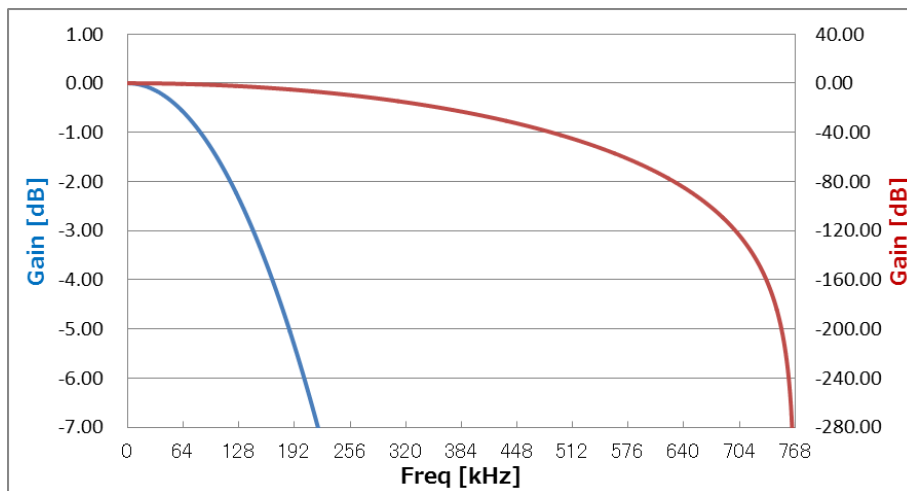

Figure 16. Frequency Response (fs= 768 kHz)

<b>10. DC Characteristics</b>
-------------------------------

(Ta= -40-105 °C; AVDD= 4.75-5.25 V, VDD18= 1.7-1.98 V (LDOE pin="L"))

Parameter	Symbol	Min.	Typ.	Max.	Unit
TVDD= 3.0-3.6 V (LDOE pin="H")					
High-Level Input Voltage (Note 15)	VIH	70%TVDD	-	-	V
Low-Level Input Voltage (Note 15)	VIL	-	-	30%TVDD	V
High-Level Output Voltage (Note 16) (Iout= -100 μA)	VOH	TVDD-0.5	-	-	V
Low-Level Output Voltage (Note 17) (except SDA pin: Iout= 100 μA)	VOL	-	-	0.5	V
(SDA pin: Iout= 3 mA)	VOL	-	-	0.4	V
TVDD= 1.7-1.98 V (LDOE pin="L")					
High-Level Input Voltage (Note 15)	VIH	80%TVDD	-	-	V
Low-Level Input Voltage (Note 15)	VIL	-	-	20%TVDD	V
High-Level Output Voltage (Note 16) (Iout= -100 μA)	VOH	TVDD-0.3	-	-	V
Low-Level Output Voltage (Note 17) (except SDA pin: Iout= 100 μA)	VOL	-	-	0.3	V
(SDA pin: Iout= 3 mA)	VOL	-	-	20%TVDD	V
Input Leakage Current	Iin	-	-	±10	μA

Note 15. MCLK, PDN, PW0-2, MSN, BICK (Slave Mode), LRCK (Slave Mode), TDMIN, SLOW/DCKB, SD/PMOD, CKS0/SDA (Write)/CDTI, CKS1/CAD\_I2C/CSN, CKS2/SCL/CCLK, CKS3/CAD1, DIF0/DSDSEL0, DIF1/DSDSEL1, TDM0, TDM1, PSN/CAD0\_SPI, I2C, DP, DCKS/HPFE, LDOE, ODP, TEST

Note 16. BICK (Master Mode)/DCLK, LRCK (Master Mode)/DSDOL1, DSDOR1, SDTO1/DSDOL2, SDTO2/DSDOR2, SDTO3/DSDOL3, SDTO4/DSDOR3, DSDOL4, DSDOR4, OVF

Note 17. Note.16 and SDA (Read)

The external pull-up resistors should be connected to TVDD+0.3 V or less.

### 11. Switching Characteristics

(Ta= -40 - +105 °C; AVDD= 4.75-5.25 V, TVDD= 1.7-1.98 V (LDOE pin="L") or 3.0-3.6 V (LDOE pin="H"), VDD18= 1.7-1.98 V (LDOE pin="L"), CL= 10 pF)

Parameter	Symbol	Min.	Typ.	Max.	Unit
<b>Master Clock (MCLK) Timing (Figure 17, Figure 18)</b>					
Frequency	fCLK	2.048	-	49.152	MHz
Duty Cycle	dCLK	45	-	55	%
<b>LRCK Timing (Slave mode) (Figure 17)</b>					
<b>Normal mode (TDM1-0 bits = "00")</b>					
Frequency	fs				
Normal Speed mode	fsn	8	-	54	kHz
Double Speed mode	fsd	54	-	108	kHz
Quad Speed mode	fsq	108	-	216	kHz
Oct speed mode	fso	-	384	-	kHz
Hex speed mode	fsh	-	768	-	kHz
Duty Cycle	Duty	45	-	55	%
<b>TDM128 mode (TDM1-0 bits = "01")</b>					
Frequency	fs				
Normal Speed mode	fsn	8	-	54	kHz
Double Speed mode	fsd	54	-	108	kHz
Quad Speed mode	fsq	108	-	216	kHz
High time	tLRH	1/128fs	-	-	ns
Low time	tLRL	1/128fs	-	-	ns
<b>TDM256 mode (TDM1-0 bits = "10")</b>					
Frequency	fs				
Normal Speed mode	fsn	8	-	54	kHz
Double Speed mode	fsd	54	-	108	kHz
High time	tLRH	1/256fs	-	-	ns
Low time	tLRL	1/256fs	-	-	ns
<b>TDM512 mode (TDM1-0 bits = "11")</b>					
Frequency	fs				
Normal Speed mode	fsn	8	-	54	kHz
High time	tLRH	1/512fs	-	-	ns
Low time	tLRL	1/512fs	-	-	ns
<b>LRCK Timing (Master mode) (Figure 18)</b>					
<b>Normal mode (TDM1-0 bits = "00")</b>					
Frequency	fs				
Normal Speed mode	fsn	8	-	54	kHz
Double Speed mode	fsd	54	-	108	kHz
Quad Speed mode	fsq	108	-	216	kHz
Oct speed mode	fso	-	384	-	kHz
Hex speed mode	fsh	-	768	-	kHz
Duty Cycle	Duty	-	50	-	%
<b>TDM128 mode (TDM1-0 bits = "01")</b>					
Frequency	fs				
Normal Speed mode	fsn	8	-	54	kHz
Double Speed mode	fsd	54	-	108	kHz
Quad Speed mode	fsq	108	-	216	kHz
High time	tLRH	-	1/4fs	-	ns
<b>TDM256 mode (TDM1-0 bits = "10")</b>					
Frequency	fs				
Normal Speed mode	fsn	8	-	54	kHz
Double Speed mode	fsd	54	-	108	kHz
High time	tLRH	-	1/8fs	-	ns
<b>TDM512 mode (TDM1-0 bits = "11")</b>					
Frequency	fs				
Normal Speed mode	fsn	8	-	54	kHz
High time	tLRH	-	1/16fs	-	ns

Note 18. When the 1024fs, 512fs or 768fs /256fs or 384fs /128fs or 192fs are switched, the AK5578 should be reset by the PDN pin or RSTN bit.

(Ta= -40 - +105 °C; AVDD= 4.75-5.25 V, TVDD= 1.7-1.98 V (LDOE pin="L") or 3.0-3.6 V (LDOE pin="H"), VDD18= 1.7-1.98 V (LDOE pin="L"), CL= 10 pF)

Parameter	Symbol	Min.	Typ.	Max.	Unit
<b>Audio Interface Timing (Slave mode)</b>					
<b>Normal mode (TDM1-0 bits = "00")</b> (8 kHz ≤ fs ≤ 216 kHz) (Figure 19) (LDOE pin = "H")					
BICK Period					
Normal Speed mode	tBCK	1/128fsn	-	-	ns
Double Speed mode	tBCK	1/128fsd	-	-	ns
Quad Speed mode	tBCK	1/64fsq	-	-	ns
BICK Pulse Width Low	tBCKL	32	-	-	ns
BICK Pulse Width High	tBCKH	32	-	-	ns
LRCK Edge to BICK "↑" (Note 19)	tLRB	25	-	-	ns
BICK "↑" to LRCK Edge (Note 19)	tBLR	25	-	-	ns
LRCK to SDTO (MSB) (Except I <sup>2</sup> S mode)	tLRS	-	-	25	ns
BICK "↓" to SDTO1/2/3/4	tBSD	-	-	25	ns
<b>Normal mode (TDM1-0 bits = "00")</b> (8 kHz ≤ fs ≤ 216 kHz) (Figure 19) (LDOE pin = "L")					
BICK Period					
Normal Speed mode (8 kHz ≤ fs ≤ 48 kHz)	tBCK	1/128fsn	-	-	ns
Double Speed mode (48 kHz ≤ fs ≤ 96 kHz)	tBCK	1/128fsd	-	-	ns
Quad Speed mode (96 kHz ≤ fs ≤ 192 kHz)	tBCK	1/64fsq	-	-	ns
BICK Pulse Width Low	tBCKL	36	-	-	ns
BICK Pulse Width High	tBCKH	36	-	-	ns
LRCK Edge to BICK "↑" (Note 19)	tLRB	30	-	-	ns
BICK "↑" to LRCK Edge (Note 19)	tBLR	30	-	-	ns
LRCK to SDTO (MSB) (Except I <sup>2</sup> S mode)	tLRS	-	-	30	ns
BICK "↓" to SDTO1/2/3/4	tBSD	-	-	30	ns
<b>Normal mode (TDM1-0 bits = "00")</b> (fs = 384 kHz, 768 kHz) (Figure 20)					
BICK Period					
Oct Speed mode	tBCK	1/64fso	-	-	ns
Hex Speed mode	tBCK	1/48fsh	-	-	ns
BICK Pulse Width Low	tBCKL	12	-	-	ns
BICK Pulse Width High	tBCKH	12	-	-	ns
LRCK Edge to BICK "↑" (Note 19)	tLRB	12	-	-	ns
BICK "↑" to LRCK Edge (Note 19)	tBLR	12	-	-	ns
BICK "↑" to SDTO1/2/3/4	tBSDD	5	-	22	ns

Note 18. When the 1024fs, 512fs or 768fs /256fs or 384fs /128fs or 192fs are switched, the AK5578 should be reset by the PDN pin or RSTN bit.

Note 19. BICK rising edge must not occur at the same time as LRCK edge.

(Ta= -40 - +105 °C; AVDD= 4.75-5.25 V, TVDD= 1.7-1.98 V (LDOE pin="L") or 3.0-3.6 V (LDOE pin="H"), VDD18= 1.7-1.98 V (LDOE pin="L"), CL= 10 pF)

Parameter	Symbol	Min.	Typ.	Max.	Unit
<b>Audio Interface Timing (Slave mode) (Figure 21)</b>					
<b>TDM128 mode (TDM1-0 bits = "01")</b>					
BICK Period					
Normal Speed mode	tBCK	1/128fsn	-	-	ns
Double Speed mode	tBCK	1/128fsd	-	-	ns
Quad Speed mode	tBCK	1/128fsq	-	-	ns
BICK Pulse Width Low	tBCKL	14	-	-	ns
BICK Pulse Width High	tBCKH	14	-	-	ns
LRCK Edge to BICK "↑" (Note 19)	tLRB	14	-	-	ns
BICK "↑" to LRCK Edge (Note 19)	tBLR	14	-	-	ns
BICK "↑" to SDTO1/2/3/4	tBSDD	5	-	30	ns
TDMIN Hold Time	tSDH	5	-	-	ns
TDMIN Setup Time	tSDS	5	-	-	ns
<b>TDM256 mode (TDM1-0 bits = "10")</b>					
BICK Period					
Normal Speed mode	tBCK	1/256fsn	-	-	ns
Double Speed mode	tBCK	1/256fsd	-	-	ns
BICK Pulse Width Low	tBCKL	14	-	-	ns
BICK Pulse Width High	tBCKH	14	-	-	ns
LRCK Edge to BICK "↑" (Note 19)	tLRB	14	-	-	ns
BICK "↑" to LRCK Edge (Note 19)	tBLR	14	-	-	ns
BICK "↑" to SDTO1/2/3/4	tBSDD	5	-	30	ns
TDMIN Hold Time	tSDH	5	-	-	ns
TDMIN Setup Time	tSDS	5	-	-	ns
<b>TDM512 mode (TDM1-0 bits = "11")</b>					
BICK Period					
Normal Speed mode	tBCK	1/512fsn	-	-	ns
BICK Pulse Width Low	tBCKL	14	-	-	ns
BICK Pulse Width High	tBCKH	14	-	-	ns
LRCK Edge to BICK "↑" (Note 19)	tLRB	14	-	-	ns
BICK "↑" to LRCK Edge (Note 19)	tBLR	14	-	-	ns
BICK "↑" to SDTO1/2/3/4	tBSDD	5	-	30	ns
TDMIN Hold Time	tSDH	5	-	-	ns
TDMIN Setup Time	tSDS	5	-	-	ns

Note 18. When the 1024fs, 512fs or 768fs /256fs or 384fs /128fs or 192fs are switched, the AK5578 should be reset by the PDN pin or RSTN bit.

Note 19. BICK rising edge must not occur at the same time as LRCK edge.

(Ta= -40 - +105 °C; AVDD= 4.75-5.25 V, TVDD= 1.7-1.98 V (LDOE pin="L") or 3.0-3.6 V (LDOE pin="H"), VDD18= 1.7-1.98 V (LDOE pin="L"), CL= 10 pF)

Parameter	Symbol	Min.	Typ.	Max.	Unit
<b>Audio Interface Timing (Master mode) (Figure 22)</b>					
<b>Normal mode (TDM1-0 bits = "00")</b> (8 kHz ≤ fs ≤ 216 kHz)					
BICK Period					
Normal Speed mode	tBCK	-	1/64fsn	-	ns
Double Speed mode	tBCK	-	1/64fsd	-	ns
Quad Speed mode	tBCK	-	1/64fsq	-	ns
BICK Duty	dBCK	-	50	-	%
BICK "↓" to LRCK Edge	tMBLR	-20	-	20	ns
BICK "↓" to SDTO1/2/3/4	tBSD	-20	-	20	ns
<b>Normal mode (TDM1-0 bits = "00")</b> (fs = 384kHz, 768 kHz) (LDOE pin = "H")					
BICK Period					
Oct speed mode	tBCK	-	1/64fso	-	ns
Hex speed mode	tBCK	-	1/64fsh	-	ns
BICK Duty	dBCK	-	50	-	%
BICK "↓" to LRCK Edge	tMBLR	-4	-	4	ns
BICK "↓" to SDTO1/2/3/4	tBSD	-4	-	4	ns
<b>Normal mode (TDM1-0 bits = "00")</b> (fs = 384 kHz, 768 kHz) (LDOE pin = "L")					
BICK Period					
Oct speed mode	tBCK	-	1/64fso	-	ns
Hex speed mode	tBCK	-	1/48fsh	-	ns
BICK Duty	dBCK	-	50	-	%
BICK "↓" to LRCK Edge	tMBLR	-5	-	5	ns
BICK "↓" to SDTO1/2/3/4	tBSD	-5	-	5	ns

Note 18. When the 1024fs, 512fs or 768fs /256fs or 384fs /128fs or 192fs are switched, the AK5578 should be reset by the PDN pin or RSTN bit.

(Ta= -40 - +105 °C; AVDD= 4.75-5.25 V, TVDD= 1.7-1.98 V (LDOE pin="L") or 3.0-3.6 V (LDOE pin="H"), VDD18= 1.7-1.98 V (LDOE pin="L"), CL= 10 pF)

Parameter	Symbol	Min.	Typ.	Max.	Unit
<b>Audio Interface Timing (Master mode) (Figure 22)</b>					
<b>TDM128 mode (TDM1-0 bits = "01")</b>					
BICK Period					
Normal Speed mode	tBCK	-	1/128fsn	-	ns
Double Speed mode	tBCK	-	1/128fsd	-	ns
Quad Speed mode	tBCK	-	1/128fsq	-	ns
BICK Duty	dBCK	-	50	-	%
BICK "↓" to LRCK Edge	tMBLR	-5	-	5	ns
BICK "↓" to SDTO1/2	tBSD	-5	-	5	ns
TDMIN Hold Time	tSDH	5	-	-	ns
TDMIN Setup Time	tSDS	5	-	-	ns
<b>TDM256 mode (TDM1-0 bits = "10")</b>					
BICK Period					
Normal Speed mode	tBCK	-	1/256fsn	-	ns
Double Speed mode	tBCK	-	1/256fsd	-	ns
BICK Duty	dBCK	-	50	-	%
BICK "↓" to LRCK Edge	tMBLR	-5	-	5	ns
BICK "↓" to SDTO1	tBSD	-5	-	5	ns
TDMIN Hold Time	tSDH	5	-	-	ns
TDMIN Setup Time	tSDS	5	-	-	ns
<b>TDM512 mode (TDM1-0 bits = "11")</b>					
BICK Period					
Normal Speed mode	tBCK	-	1/512fsn	-	ns
BICK Duty	dBCK	-	50	-	%
BICK "↓" to LRCK Edge	tMBLR	-5	-	5	ns
BICK "↓" to SDTO1	tBSD	-5	-	5	ns
TDMIN Hold Time	tSDH	5	-	-	ns
TDMIN Setup Time	tSDS	5	-	-	ns

Note 18. When the 1024fs, 512fs or 768fs /256fs or 384fs /128fs or 192fs are switched, the AK5578 should be reset by the PDN pin or RSTN bit.

(Ta= -40 - +105 °C; AVDD= 4.75-5.25 V, TVDD= 1.7-1.98 V (LDOE pin="L") or 3.0-3.6 V (LDOE pin="H"), VDD18= 1.7-1.98 V (LDOE pin="L"), CL= 10 pF)

Parameter	Symbol	Min.	Typ.	Max.	Unit
<b>Audio Interface Timing (Master mode) (Figure 23)</b>					
<b>DSD Audio Interface Timing (64fs mode, DSDSEL 1-0 bits = "00")</b>					
DCLK Period	tDCK	-	1/64fs	-	ns
DCLK Pulse Width Low	tDCKL	144	-	-	ns
DCLK Pulse Width High	tDCKH	144	-	-	ns
DCLK Edge to DSDOL/R (Note 20)	tDDD	-20	-	20	ns
<b>DSD Audio Interface Timing (128fs mode, DSDSEL 1-0 bits = "01")</b>					
DCLK Period	tDCK	-	1/128fs	-	ns
DCLK Pulse Width Low	tDCKL	72	-	-	ns
DCLK Pulse Width High	tDCKH	72	-	-	ns
DCLK Edge to DSDOL/R (Note 20)	tDDD	-10	-	10	ns
<b>DSD Audio Interface Timing (256fs mode, DSDSEL 1-0 bits = "10")</b>					
DCLK Period	tDCK	-	1/256fs	-	ns
DCLK Pulse Width Low	tDCKL	36	-	-	ns
DCLK Pulse Width High	tDCKH	36	-	-	ns
DCLK Edge to DSDOL/R (Note 20)	tDDD	-10	-	10	ns

Note 18. When the 1024fs, 512fs or 768fs /256fs or 384fs /128fs or 192fs are switched, the AK5578 should be reset by the PDN pin or RSTN bit.

Note 20. tDDD is defined from a falling edge of DCLK "↓" to a DSDOL/R edge when DCKB bit = "0" and it is defined from a rising edge of DCLK "↑" to a DSDOL/R edge when DCKB bit = "1".



(Ta= -40 - +105 °C; AVDD= 4.75-5.25 V, TVDD= 1.7-1.98 V (LDOE pin="L") or 3.0-3.6 V (LDOE pin="H"), VDD18= 1.7-1.98 V (LDOE pin="L"), CL= 10 pF)

Parameter	Symbol	Min.	Typ.	Max.	Unit
<b>Control Interface Timing (3-Wire Serial mode):</b> (Figure 25) (Figure 26)					
CCLK Period	tCCK	200	-	-	ns
CCLK Pulse Width Low	tCCKL	80	-	-	ns
Pulse Width High	tCCKH	80	-	-	ns
CDTI Setup Timing	tCDS	40	-	-	ns
CDTI Hold Timing	tCDH	40	-	-	ns
CSN "H" Time	tCSW	150	-	-	ns
CSN "↓" to CCLK "↑"	tCSS	50	-	-	ns
CCLK "↑" to CSN "↑"	tCSH	50	-	-	ns
<b>Control Interface Timing (I<sup>2</sup>C Bus mode):</b> (Figure 27)					
SCL CLOCK Frequency	fSCL	-	-	400	kHz
Bus Free Time Between Transmissions	tBUF	1.3	-	-	μs
Start Condition Hold Tune (Prior to First Clock Pulse)	tHD STA	0.6	-	-	μs
Clock Low Time	tLow	1.3	-	-	μs
Clock High Time	tHIGH	0.6	-	-	μs
Setup Time for Repeated Start Condition	tSU STA	0.6	-	-	μs
SDA Hold Time from SCL Falling (Note 21)	tHD DAT	0	-	-	μs
SDA Setup Time from SCL Rising	tSU DAT	0.1	-	-	μs
Rise Time of Both SDA and SCL Lines	tR	-	-	1.0	μs
Fall Time of Both SDA and SCL Lines	tF	-	-	0.3	μs
Setup Time for Stop Condition	tSU STO	0.6	-	-	μs
Pulse Width of Spike Noise Suppressed by Input Filter	tSP	0	-	50	ns
Capacitive Load on Bus	Cb	-	-	400	pF
<b>Power Down &amp; Reset Timing</b> (Figure 28)					
PDN Pulse Width (Note 22)	tPD	150	-	-	ns
PDN Reject Pulse Width (Note 22)	tRPD	-	-	30	ns
PDN "↑" to SDTO1-4 valid (Note 23)	tPDV	-	583	-	1/fs

Note 21. Data must be held for sufficient time to bridge the 300 ns transition time of SCL.

Note 22. The AK5578 can be reset by setting the PDN pin to "L" upon power-up. The PDN pin must held "L" for more than 150 ns for a certain reset. The AK5578 is not reset by the "L" pulse less than 30 ns.

Note 23. This cycle is the number of LRCK rising edges from the PDN pin = "H".

■ Timing Diagram

[1] PCM Mode

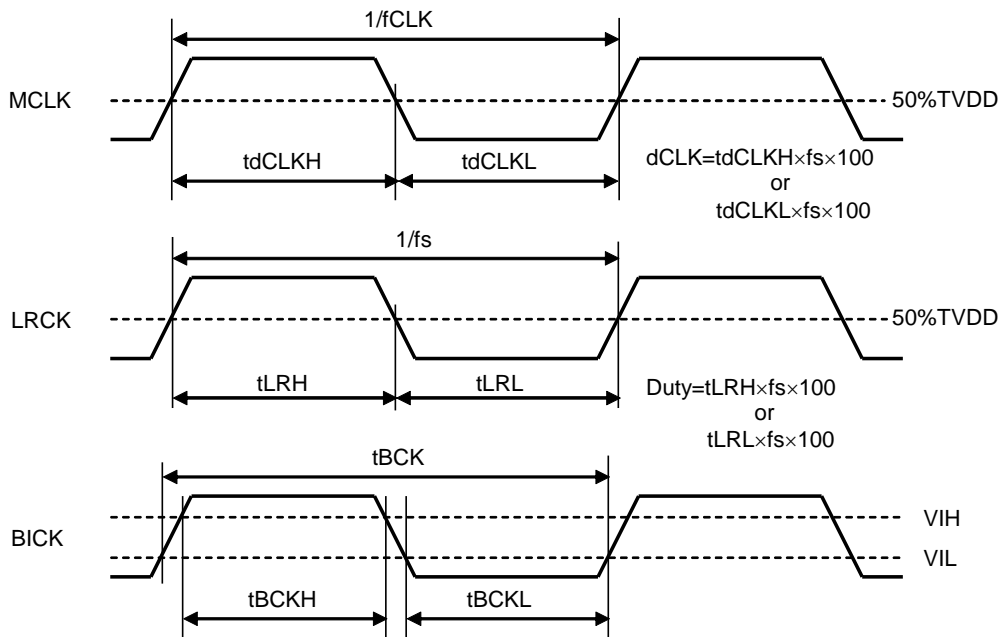

Figure 17. Clock Timing (Slave Mode)

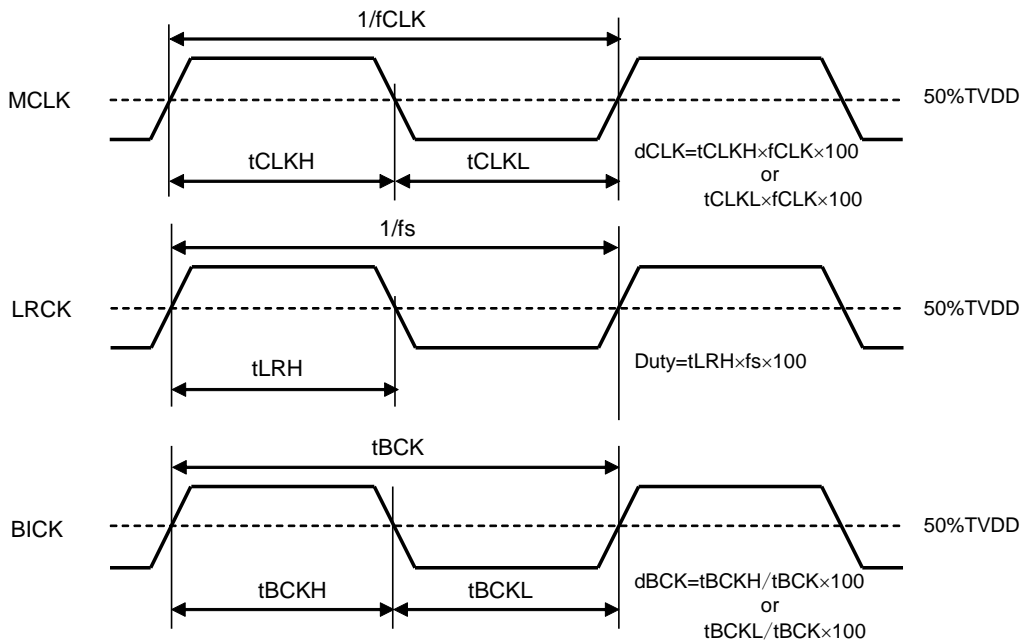

Figure 18. Clock Timing (Master Mode)

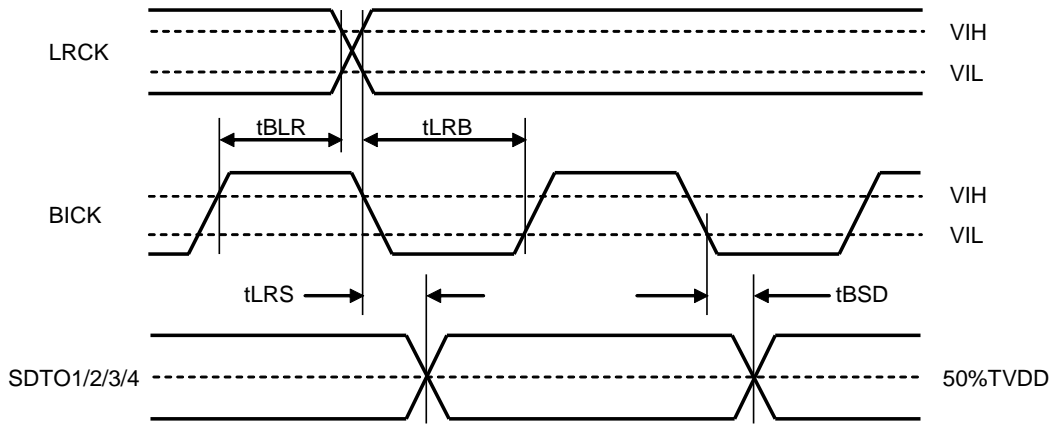

Figure 19. Audio Interface Timing (Normal Mode & Slave Mode:  $8\text{ kHz} \leq f_s \leq 216\text{ kHz}$ )

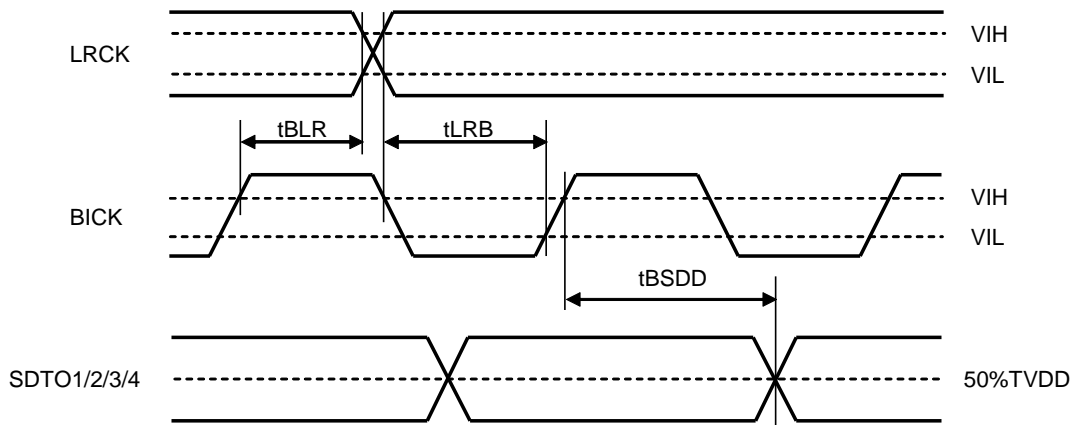

Figure 20. Audio Interface Timing (Normal & Slave Mode:  $f_s=384\text{ kHz}, 768\text{ kHz}$ )

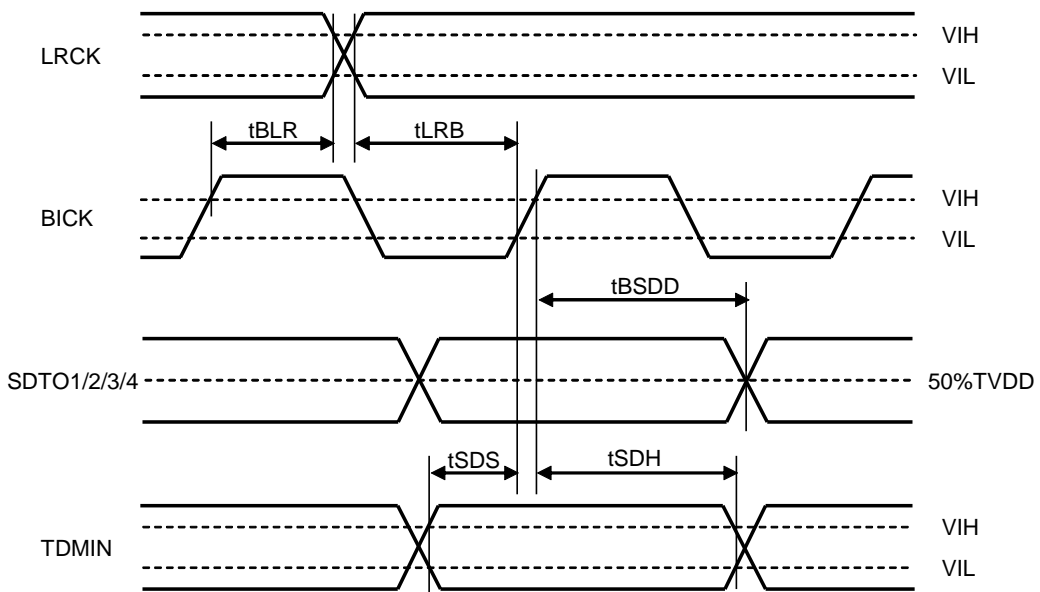

Figure 21. Audio Interface Timing (TDM & Slave Mode)

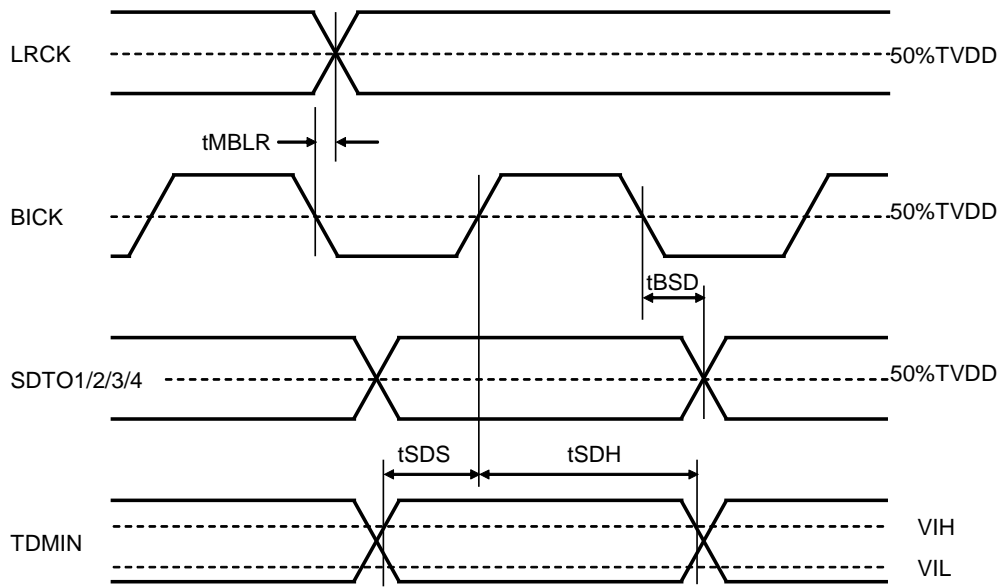

Figure 22. Audio Interface Timing (Master Mode)

[2] DSD Mode

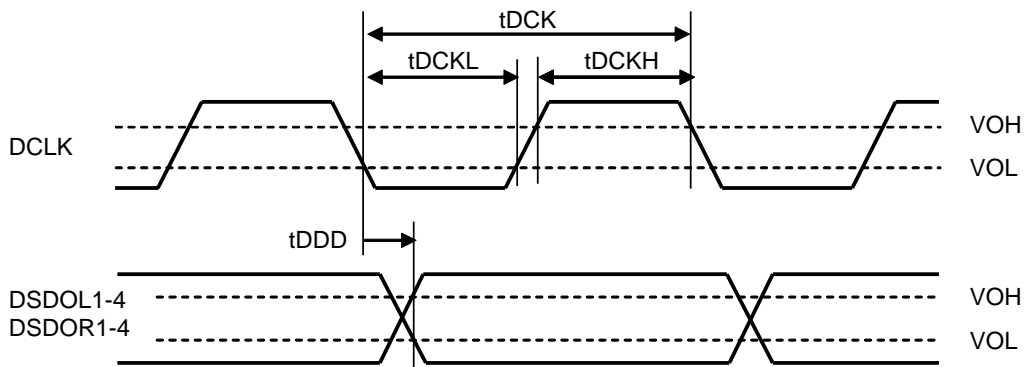

Figure 23. Audio Serial Interface Timing (Normal Mode, DCKB bit= "0" or DCKB pin= "L")

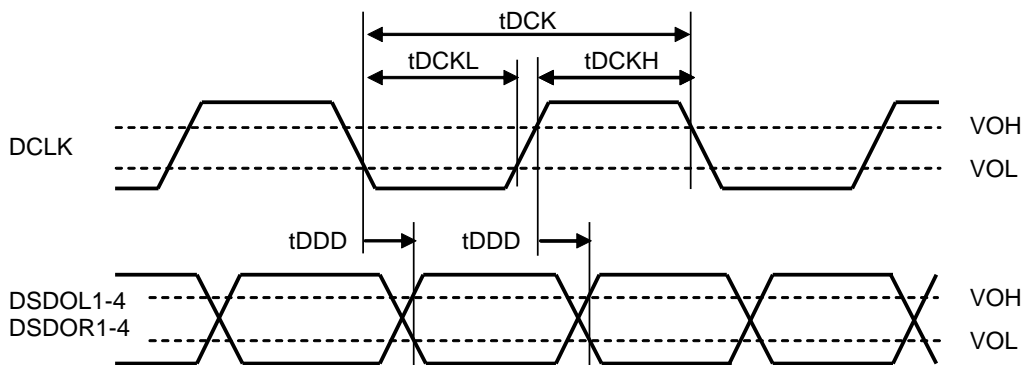

Figure 24. Audio Serial Interface Timing (Phase Modulation Mode, DCKB bit= "0" or DCKB pin= "L")

[3] 3-Wire Serial Interface

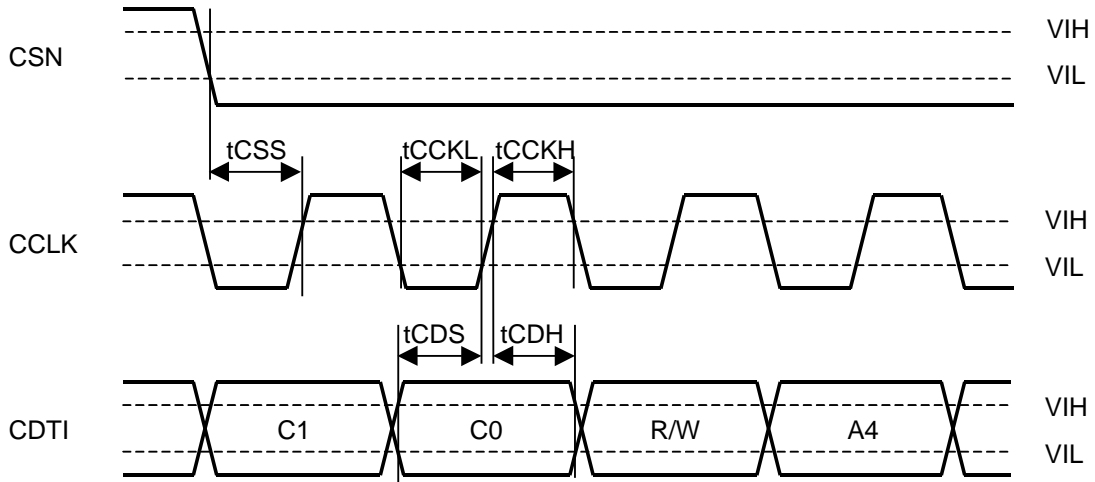

Figure 25. WRITE Command Input Timing (3-wire Serial Mode)

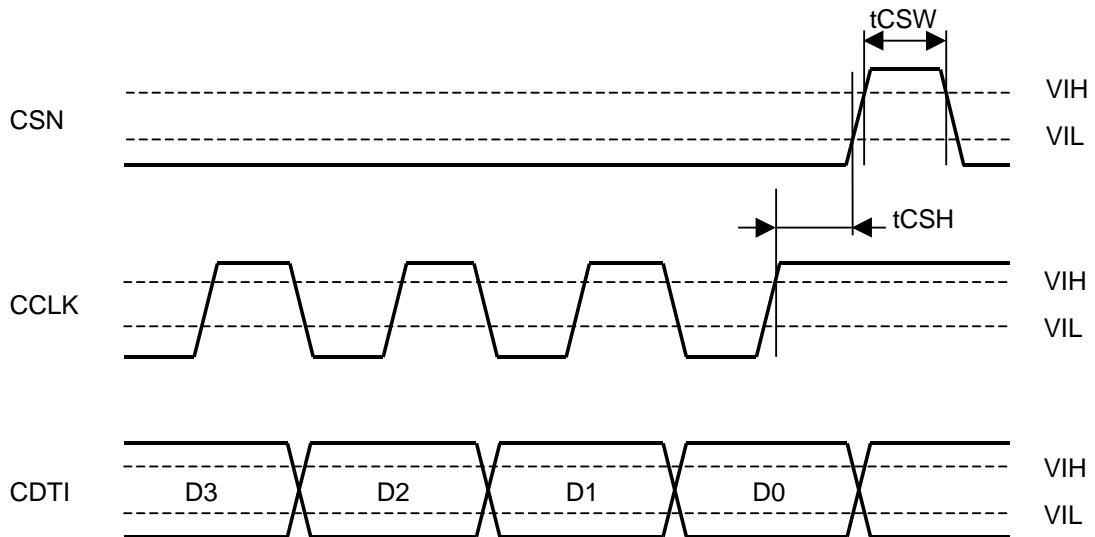

Figure 26. WRITE Data Input Timing (3-wire Serial Mode)

[4] I<sup>2</sup>C Interface

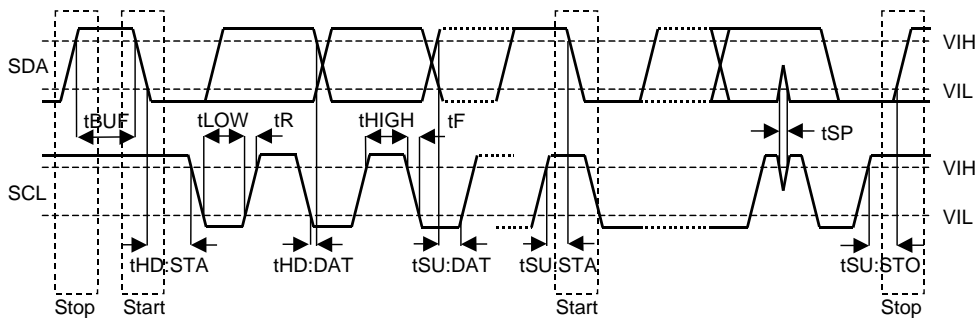

Figure 27. I<sup>2</sup>C Bus Mode Timing

[5] Power-down Timing

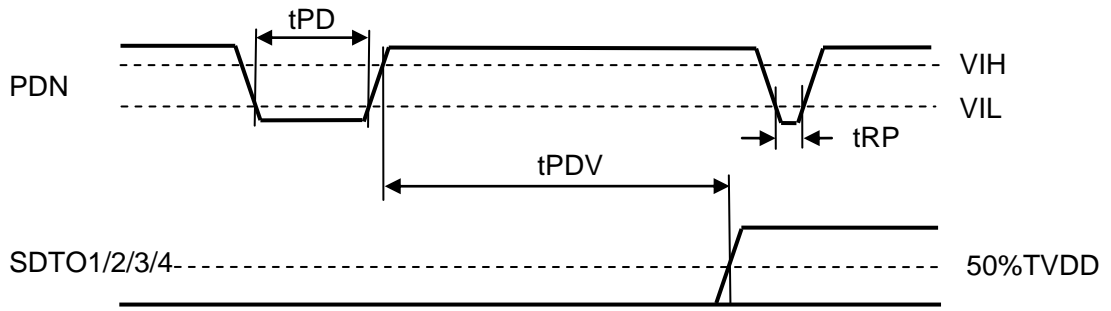

Figure 28. Power-down & Reset Timing

## 12. Functional Descriptions

### ■ Digital Core Power Supply

The digital core of the AK5578 is operates off of a 1.8 V power supply. Normally, this voltage is generated by the internal LDO from TVDD (3.3 V) for digital interface. The internal LDO will be powered up by setting the LDOE pin = "H". Set the LDOE pin to "L" and supply a 1.8 V power to the VDD18 pin externally when a 1.8 V is used as TVDD.

### ■ Output Mode

The AK5578 is able to output either PCM or DSD data. The DP pin or DP bit select the output mode. Set the PW2 pin = PW1 pin = PW0 pin = "L" or RSTN bit = "0" or PW8-1 bits = "0H" to reset all channels when changing the PCM/DSD mode. The AK5578 outputs data from the SDTO1-4 pins by BICK and LRCK in PCM mode. DSD data are output from the DSDOL1-4 pins and DSDOR1-4 pins by DCLK in DSD mode.

DP pin	DP bit	Interface
L	0	PCM
H	1	DSD

Table 1 PCM/DSD Mode Control

### ■ Master Mode and Slave Mode

The AK5578 requires a master clock (MCLK), an audio serial data clock (BICK) and an output channel clock (LRCK) in PCM mode. In this case, the LRCK frequency will be the sampling frequency. Both master and slave modes are available in PCM mode. In master mode, the AK5578 internally generates BICK and LRCK clocks from MCLK inputs and outputs them from the BICK pin and the LRCK pin. In slave mode, AK5578 operates in the input MCLK, BICK and LRCK. MCLK must be synchronized with BICK and LRCK but the phase is not important. The AK5578 is in master mode when the MSN pin = "H" and in slave mode when the MSN pin = "L".

The AK5578 requires a master clock (MCLK) in DSD mode. Slave mode is not available in DSD mode, only master mode is supported.

### ■ System Clock

[1] PCM mode

The external system clocks, which are required to operate the AK5578, are MCLK, BICK and LRCK in PCM mode. MCLK frequency is determined based on LRCK frequency, according to the operation mode. [Table 2](#), [Table 3](#), [Table 4](#) show MCLK frequencies correspond to the normal audio rate. Set the frequency ratio between Sampling frequency and MCLK by the CKS3-0 pins ([Table 5](#))

All channels must be reset when changing the clock mode or audio interface format by the CKS2-0 pins (bits), TDM1-0 pins (bits), DIF1-0 pins (bits) and the MSN pin. In parallel control mode, all channels will be reset by the PDN pin = "L" or PW2-0 pins = "LLL". In serial control mode, all channels will be reset by RSTN bit = "0" or PW8-1 bits = "0H". A stable clock must be supplied after releasing the reset.

The AK5578 integrates a phase detection circuit for LRCK. If the internal timing becomes out of synchronization in slave mode, the AK5578 is reset automatically and the phase is resynchronized.

The following sequence must be executed when synchronizing multiple AK5578's. Stop all AK5578's in reset status by setting the PDN pin = "L" → "H" after stopping the system clock. Make pin or register settings while all channels are in reset status. After that, input the same system clock to all AK5578's.

fs	MCLK										
	32fs	48fs	64fs	96fs	128fs	192fs	256fs	384fs	512fs	768fs	1024fs
32 kHz	N/A	N/A	N/A	N/A	N/A	N/A	8.192 MHz	12.288 MHz	16.384 MHz	24.576 MHz	32.768 MHz
48 kHz	N/A	N/A	N/A	N/A	N/A	N/A	12.288 MHz	18.432 MHz	24.576 MHz	36.864 MHz	N/A
96 kHz	N/A	N/A	N/A	N/A	N/A	N/A	24.576 MHz	36.864 MHz	N/A	N/A	N/A
192 kHz	N/A	N/A	N/A	N/A	24.576 MHz	36.864 MHz	N/A	N/A	N/A	N/A	N/A
384 kHz	N/A	N/A	24.576 MHz	36.864 MHz	N/A	N/A	N/A	N/A	N/A	N/A	N/A
768 kHz	24.576 MHz	36.864 MHz	N/A	N/A	N/A	N/A	N/A	N/A	N/A	N/A	N/A

(N/A: Not Available)

Table 2. System Clock Example (Slave Mode)

fs	MCLK										
	32fs	48fs	64fs	96fs	128fs	192fs	256fs	384fs	512fs	768fs	1024fs
32 kHz	N/A	N/A	N/A	N/A	N/A	N/A	8.192 MHz	12.288 MHz	16.384 MHz	24.576 MHz	32.768 MHz
48 kHz	N/A	N/A	N/A	N/A	N/A	N/A	12.288 MHz	18.432 MHz	24.576 MHz	36.864 MHz	N/A
96 kHz	N/A	N/A	N/A	N/A	N/A	N/A	24.576 MHz	36.864 MHz	N/A	N/A	N/A
192 kHz	N/A	N/A	N/A	N/A	24.576 MHz	36.864 MHz	N/A	N/A	N/A	N/A	N/A
384 kHz	N/A	N/A	24.576 MHz	36.864 MHz	N/A	N/A	N/A	N/A	N/A	N/A	N/A
768 kHz	24.576 MHz	36.864 MHz	49.152 MHz	N/A	N/A	N/A	N/A	N/A	N/A	N/A	N/A

(N/A: Not Available)

Table 3. System Clock Example (Master Mode)

fs	MCLK										
	32fs	48fs	64fs	96fs	128fs	192fs	256fs	384fs	512fs	768fs	1024fs
32 kHz	N/A	N/A	N/A	N/A	N/A	N/A	N/A	N/A	16.384 MHz	24.576 MHz	32.768 MHz
48 kHz	N/A	N/A	N/A	N/A	N/A	N/A	N/A	N/A	24.576 MHz	36.864 MHz	N/A
96 kHz	N/A	N/A	N/A	N/A	N/A	N/A	24.576 MHz	36.864 MHz	N/A	N/A	N/A
192 kHz	N/A	N/A	N/A	N/A	24.576 MHz	36.864 MHz	N/A	N/A	N/A	N/A	N/A
384 kHz	N/A	N/A	24.576 MHz	36.864 MHz	N/A	N/A	N/A	N/A	N/A	N/A	N/A
768 kHz	24.576 MHz	36.864 MHz	NA	N/A	N/A	N/A	N/A	N/A	N/A	N/A	N/A

(N/A: Not Available)

Table 4. System Clock Example (Auto Mode)



CKS3 pin(bit)	CKS2 pin(bit)	CKS1 pin(bit)	CKS0 pin(bit)	MSN pin	MCLK Frequency	Speed Mode fs Range
L(0)	L(0)	L(0)	L(0)	L	128fs	Quad Speed
				H	24M	108 kHz < fs ≤ 216 kHz
L(0)	L(0)	L(0)	H(1)	L	192fs	Quad Speed
				H	36M	108 kHz < fs ≤ 216 kHz
L(0)	L(0)	H(1)	L(0)	L	256fs	Normal Speed
				H	12M	8 kHz ≤ fs ≤ 54 kHz
L(0)	L(0)	H(1)	H(1)	L	256fs	Double Speed
				H	24M	54 kHz < fs ≤ 108 kHz
L(0)	H(1)	L(0)	L(0)	L	384fs	Double Speed
				H	36M	54 kHz < fs ≤ 108 kHz
L(0)	H(1)	L(0)	H(1)	L	384fs	Normal Speed
				H	18M	8 kHz ≤ fs ≤ 54 kHz
L(0)	H(1)	H(1)	L(0)	L	512fs	Normal Speed
				H	24M	8 kHz < fs ≤ 54 kHz
L(0)	H(1)	H(1)	H(1)	L	768fs	Normal Speed
				H	36M	8 kHz ≤ fs ≤ 54 kHz
H(1)	L(0)	L(0)	L(0)	L	64fs	Oct Speed
				H	24M	fs = 384 kHz
H(1)	L(0)	L(0)	H(1)	L	32fs	Hex Speed
				H	24M	fs = 768 kHz
H(1)	L(0)	H(1)	L(0)	L	96fs	Oct Speed
				H	36M	fs = 384 kHz
H(1)	L(0)	H(1)	H(1)	L	48fs	Hex Speed
				H	36M	fs = 768 kHz
H(1)	H(1)	L(0)	L(0)	L	NA	NA
				H	64fs 49.1M	Hex Speed fs = 768 kHz
H(1)	H(1)	L(0)	H(1)	L	1024fs	Normal Speed
				H	32M	8 kHz ≤ fs ≤ 32 kHz
H(1)	H(1)	H(1)	L(0)	L	NA	NA
				H	NA	NA
H(1)	H(1)	H(1)	H(1)	L	Auto	8 kHz ≤ fs ≤ 768 kHz
				H	NA	NA

Table 5. Clock Mode (fs &amp; MCLK Frequency)

## [2] DSD mode

The external clock, which is required to operate the AK5578, is MCLK in DSD mode. The AK5578 generates DCLK from MCLK inputs and DSD data outputs (DSDOL1-4 and DSDOR1-4) are synchronized with DCLK. The necessary MCLK frequencies are 512fs and 768fs ( $fs=32$  kHz, 44.1 kHz, 48 kHz). MCLK frequency can be changed by the DCKS pin (bit). After exiting reset (PDN pin = "L" → "H") upon power-up, the AK5578 is in power-down state until MCLK is input.

DCKS pin (bit)	MCLK Frequency	
L (0)	512fs	(default)
H (1)	768fs	

Table 6. System Clock (DSD Mode)

The AK5578 supports 64fs, 128fs and 256fs DSD sampling frequencies ( $fs=32$  kHz, 44.1 kHz, 48 kHz). DSDSEL1-0 pins (bits) control this setting (Table 7).

DSDSEL1 pin (bit)	DSDSEL0 pin (bit)	Frequency Mode	DSD Sampling Frequency			
			$fs=32$ kHz	$fs=44.1$ kHz	$fs=48$ kHz	
L(0)	L(0)	64fs	2.048 MHz	2.8224 MHz	3.072 MHz	(default)
L(0)	H(1)	128fs	4.096 MHz	5.6448 MHz	6.144 MHz	
H(1)	L(0)	256fs	8.192 MHz	11.2896 MHz	12.288 MHz	
H(1)	H(1)	-	Reserved	Reserved	Reserved	

Table 7. DSD Sampling Frequency Select

### ■ Audio Interface Format

TDM1-0 pins(bits), DIF1-0 pins(bits), SLOW pin(bit) and SD pin(bit) settings should be changed when all channel are reset condition.

## [1] PCM mode

48 types of audio interface format can be selected by the TDM1-0 pins (bits), MSN pin and DIF1-0 pins (bits) (Table 8, Table 9). In all formats the serial data is MSB-first, 2's complement format. In master mode, the SDTO1-4 is clocked out on the falling edge of BICK. Normal output in slave mode, the SDTO1-4 is clocked out on the falling edge of BICK if  $8$  kHz  $\leq fs \leq 216$  kHz. In other conditions, the data is clocked out on the prior rising edge of BICK to compensate for some delay that renders the edge of data transition near BICK falling edge.

Audio interface format is distinguished in four types: Normal mode, TDM128 mode, TDM256 mode and TDM512 mode are available. The TDM1-0 pins (bits) select these modes.

In Normal mode (non TDM), AIN1 and AIN2 A/D converted data is output from the SDTO1 pin, AIN3 and AIN4 A/D converted data is output from the SDTO2 pin, AIN5 and AIN6 A/D converted data is output from the SDTO3 pin, AIN7 and AIN8 A/D converted data is output from the SDTO4 pin.

The BICK frequency must be in the range from 48fs to 128fs ( $fs=48$  kHz) in slave mode if the audio interface format is in normal output (non TDM) and the interface speed is in Normal, Double or Quad mode. Bit length of A/D data is 24-bit or 32-bit and it is selected by the DIF1 pin (bit).

The BICK frequency must be set to 32fs, 48fs or 64fs in slave mode if the audio interface format is normal output (non TDM) and the interface speed is in OCT mode. Bit length of A/D data is determined by BICK frequency regardless of the DIF1 pin (bit) if the BICK frequency is 32fs or 48fs. It is 16-bit when the BICK frequency is 32fs and 24-bit when the BICK frequency is 48fs. When the BICK frequency is 64fs, A/D data can be selected between 24-bit and 32-bit by the DIF1 pin (bit).

The BICK frequency must be set to 32fs or 48fs in slave mode if the audio interface format is normal output (non TDM) and the interface speed is in EXT mode. Bit length of A/D data is determined by BICK frequency regardless of the DIF1 pin (bit). It is 16-bit when the BICK frequency is 32fs and 24-bit when the BICK frequency is 48fs.

The BICK frequency will be 64fs in master mode if the audio interface format is normal output (non TDM) and the interface speed is Normal, Double or Quad mode. Data bit length can be selected from 24-bit and 32-bit by the DIF1 pin (bit).

The MCLK frequency must be 64fs or 96fs in master mode if the audio interface format is normal output (non TDM) and the interface speed is OCT mode. The BICK frequency will be 64fs. Data bit length can be selected from 24-bit and 32-bit by the DIF1 pin (bit).

The BICK frequency will be synchronized with the MCLK frequency in master mode if the audio interface format is normal output (non TDM) and the interface speed is HEX mode. The MCLK frequency must be 32fs, 48fs or 64fs. The bit length of A/D data is 16-bit when the MCLK frequency is 32fs, 24-bit when the MCLK frequency is 48fs and 24-bit or 32-bit can be selected by the DIF1 pin (bit) when the MCLK frequency is 64fs.

The DIF0 pin selects the A/D data format between MSB justified and I<sup>2</sup>C Compatible.

No.	Multiplex Mode	Speed Mode	TDM1 pin(bit)	TDM0 pin(bit)	MSN Pin	DIF1 pin(bit)	DIF0 pin(bit)	SDTO	LRCK		BICK		MCLK	
									Pol.	I/O	Freq.	I/O	Freq.	I/O
0	Normal	Normal Double Quad	L(0)	L(0)	L	L(0)	L(0)	24-bit, MSB	H/L	I	48-128fs	I	128-1024fs	I
1						L(0)	H(1)	24-bit, I2S	L/H	I	48-128fs	I	128-1024fs	I
2						H(1)	L(0)	32-bit, MSB	H/L	I	64-128fs	I	128-1024fs	I
3						H(1)	H(1)	32-bit, I2S	L/H	I	64-128fs	I	128-1024fs	I
4					H	L(0)	L(0)	24-bit, MSB	H/L	O	64fs	O	128-1024fs	I
5						L(0)	H(1)	24-bit, I2S	L/H	O	64fs	O	128-1024fs	I
6						H(1)	L(0)	32-bit, MSB	H/L	O	64fs	O	128-1024fs	I
7						H(1)	H(1)	32-bit, I2S	L/H	O	64fs	O	128-1024fs	I
8		OCT HEX	L(0)	L(0)	L	*	L(0)	16-bit, MSB	↑	I	32fs	I	32-96fs	I
9						*	H(1)	16-bit, I2S	↓	I	32fs	I	32-96fs	I
10						*	L(0)	24-bit, MSB	↑	I	48fs	I	32-96fs	I
11						*	H(1)	24-bit, I2S	↓	I	48fs	I	32-96fs	I
12						L(0)	L(0)	24-bit, MSB	↑	I	64fs	I	32-96fs	I
13						L(0)	H(1)	24-bit, I2S	↓	I	64fs	I	32-96fs	I
14						H(1)	L(0)	32-bit, MSB	↑	I	64fs	I	32-96fs	I
15						H(1)	H(1)	32-bit, I2S	↓	I	64fs	I	32-96fs	I
16					H	*	L(0)	16-bit, MSB	↑	O	32fs	O	32fs	I
17						*	H(1)	16-bit, I2S	↓	O	32fs	O	32fs	I
18						*	L(0)	24-bit, MSB	↑	O	48fs	O	48fs	I
19						*	H(1)	24-bit, I2S	↓	O	48fs	O	48fs	I
20						L(0)	L(0)	24-bit, MSB	↑	O	64fs	O	64-96fs	I
21						L(0)	H(1)	24-bit, I2S	↓	O	64fs	O	64-96fs	I
22						H(1)	L(0)	32-bit, MSB	↑	O	64fs	O	64-96fs	I
23	H(1)					H(1)	32-bit, I2S	↓	O	64fs	O	64-96fs	I	

Table 8. Audio Interface Format (Normal Mode)

No.	Multiplex Mode	Speed Mode	TDM1 pin(bit)	TDM0 pin(bit)	MSN pin	DIF1 pin(bit)	DIF0 pin(bit)	SDTO	LRCK		BICK		MCLK	
									Edg.	I/O	Freq.	I/O	Freq.	I/O
24	TDM128	Normal Double Quad	L(0)	H(1)	L	L(0)	L(0)	24-bit, MSB	↑	I	128fs	I	128-1024fs	I
25						L(0)	H(1)	24-bit, I <sup>2</sup> S	↓	I	128fs	I	128-1024fs	I
26						H(1)	L(0)	32-bit, MSB	↑	I	128fs	I	128-1024fs	I
27						H(1)	H(1)	32-bit, I <sup>2</sup> S	↓	I	128fs	I	128-1024fs	I
28					H	L(0)	L(0)	24-bit, MSB	↑	O	128fs	O	128-1024fs	I
29						L(0)	H(1)	24-bit, I <sup>2</sup> S	↓	O	128fs	O	128-1024fs	I
30						H(1)	L(0)	32-bit, MSB	↑	O	128fs	O	128-1024fs	I
31						H(1)	H(1)	32-bit, I <sup>2</sup> S	↓	O	128fs	O	128-1024fs	I
32	TDM256	Normal Double	H(1)	L(0)	L	L(0)	L(0)	24-bit, MSB	↑	I	256fs	I	256-1024fs	I
33						L(0)	H(1)	24-bit, I <sup>2</sup> S	↓	I	256fs	I	256-1024fs	I
34						H(1)	L(0)	32-bit, MSB	↑	I	256fs	I	256-1024fs	I
35						H(1)	H(1)	32-bit, I <sup>2</sup> S	↓	I	256fs	I	256-1024fs	I
36					H	L(0)	L(0)	24-bit, MSB	↑	O	256fs	O	256-1024fs	I
37						L(0)	H(1)	24-bit, I <sup>2</sup> S	↓	O	256fs	O	256-1024fs	I
38						H(1)	L(0)	32-bit, MSB	↑	O	256fs	O	256-1024fs	I
39						H(1)	H(1)	32-bit, I <sup>2</sup> S	↓	O	256fs	O	256-1024fs	I
40	TDM512	Normal	H(1)	H(1)	L	L(0)	L(0)	24-bit, MSB	↑	I	512fs	I	256-1024fs	I
41						L(0)	H(1)	24-bit, I <sup>2</sup> S	↓	I	512fs	I	256-1024fs	I
42						H(1)	L(0)	32-bit, MSB	↑	I	512fs	I	256-1024fs	I
43						H(1)	H(1)	32-bit, I <sup>2</sup> S	↓	I	512fs	I	256-1024fs	I
44					H	L(0)	L(0)	24-bit, MSB	↑	O	512fs	O	512-1024fs	I
45						L(0)	H(1)	24-bit, I <sup>2</sup> S	↓	O	512fs	O	512-1024fs	I
46						H(1)	L(0)	32-bit, MSB	↑	O	512fs	O	512-1024fs	I
47						H(1)	H(1)	32-bit, I <sup>2</sup> S	↓	O	512fs	O	512-1024fs	I

Table 9. Audio Interface Format (TDM Mode)

## Cascade Connection in TDM Mode

The AK5578 supports cascade connection in TDM mode. All A/D converted data of connected AK5578 are output from the SDTO1 pin of the last AK5578 by cascade connection.

When the ODP pin = "L", a cascade connection of two devices in TDM512 mode is supported. Figure 29 shows a connection example. When the ODP pin = "H", a cascade connection of two up to sixteen devices is available.

When using multiple devices in slave mode on cascade connection, internal operation timing of each device may differ for one MCLK cycle depending on MCLK and BICK input timings. To prevent this timing difference, BICK "↓" should be more than  $\pm 10\text{ns}$  from MCLK "↑" as shown in Table 10. To realize this timing, BICK divided by two should be input on a falling edge of MCLK as shown in Figure 54 when  $\text{MCLK}=2\times\text{BICK}$  (normal speed 1024fs mode). When  $\text{MCLK}=\text{BICK}$  (normal speed 512fs mode), MCLK and BICK should be input in-phase as shown in Figure 55 to satisfy the timing shown in Table 10

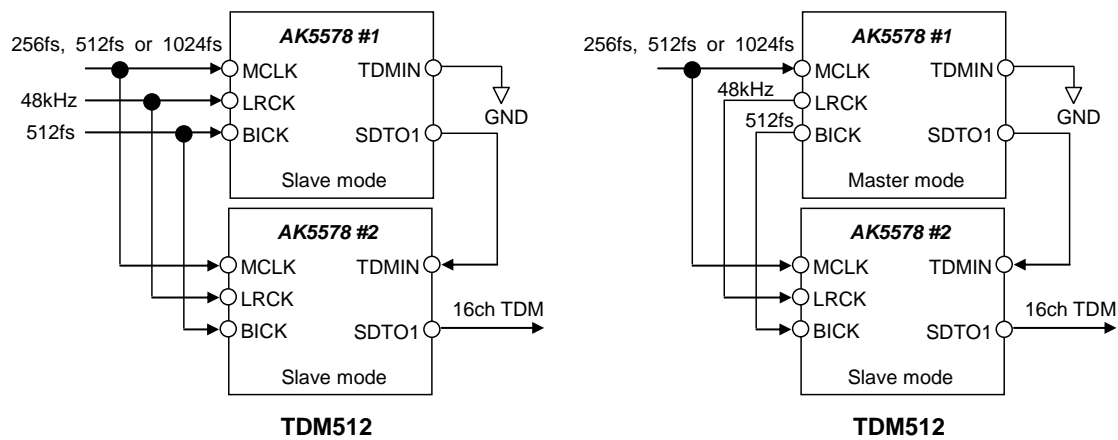

Figure 29. Cascade Connection

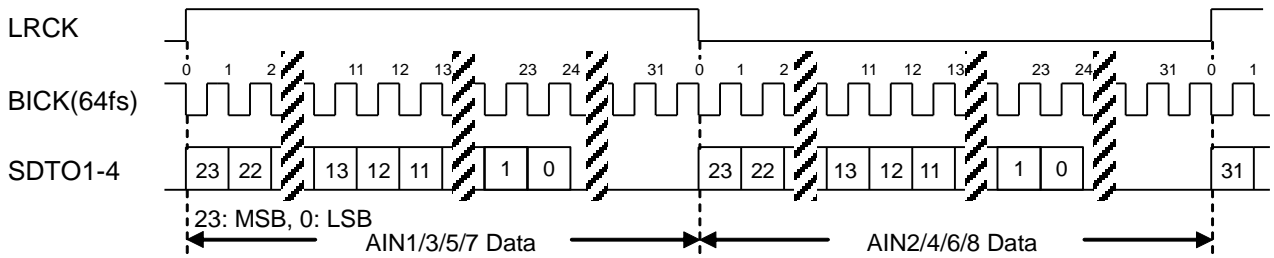

Figure 30. Mode 0/4 Timing (Normal Output, Normal/Double/Quad Speed Mode, MSB Justified, 24-bit)

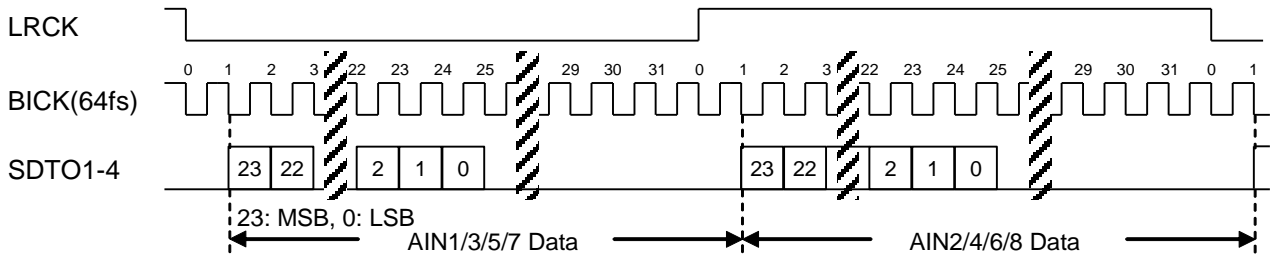

Figure 31. Mode 1/5 Timing (Normal Output, Normal/Double/Quad Speed Mode, I<sup>2</sup>S Compatible, 24-bit)

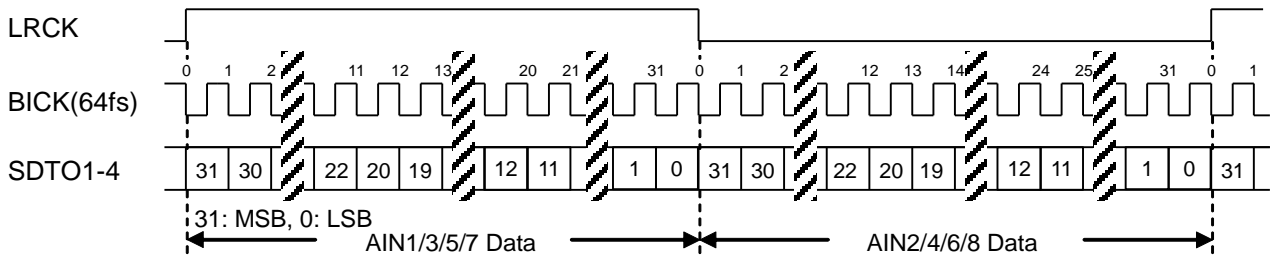

Figure 32. Mode 2/6 Timing (Normal Output, Normal/Double/Quad Speed Mode, MSB Justified, 32-bit)

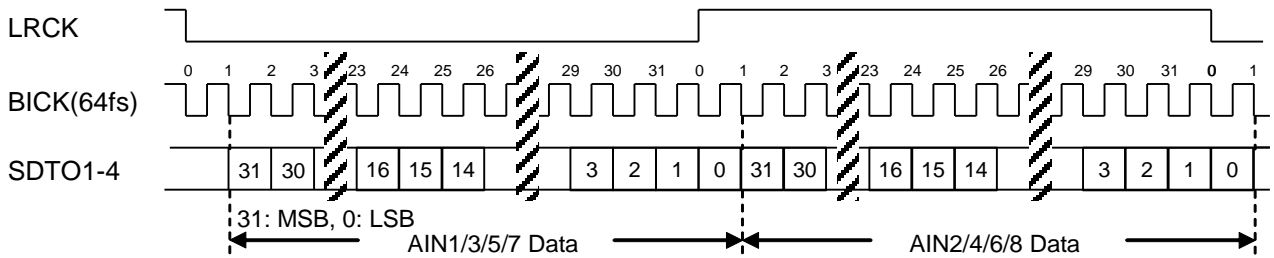

Figure 33. Mode 3/7 Timing (Normal Output, Normal/Double/Quad Speed Mode, I<sup>2</sup>S Compatible, 32-bit)

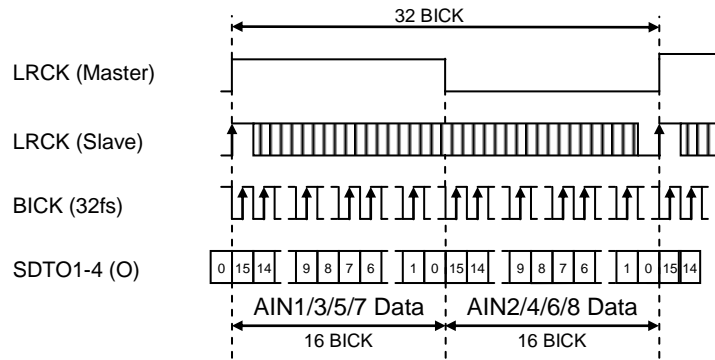

Figure 34. Mode 8/16 Timing (Normal Output, OCT/HEX Speed Mode, MSB Justified, 16-bit)

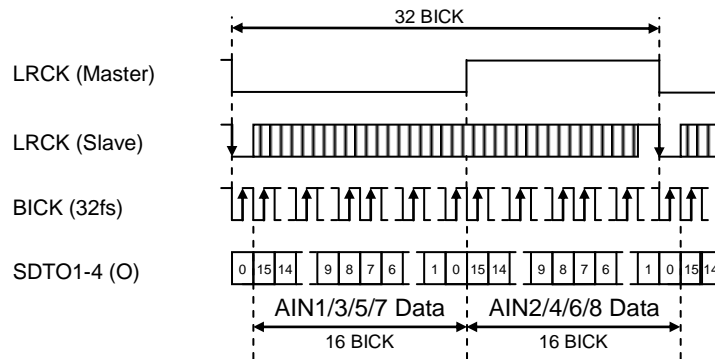

Figure 35. Mode 9/17 Timing (Normal Output, OCT/HEX Speed Mode, I<sup>2</sup>S Compatible, 16-bit)

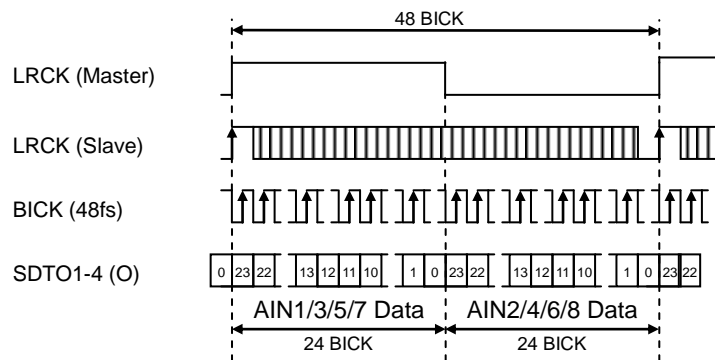

Figure 36. Mode 10/18 Timing (Normal Output, OCT/HEX Speed Mode, MSB Justified, 24-bit)

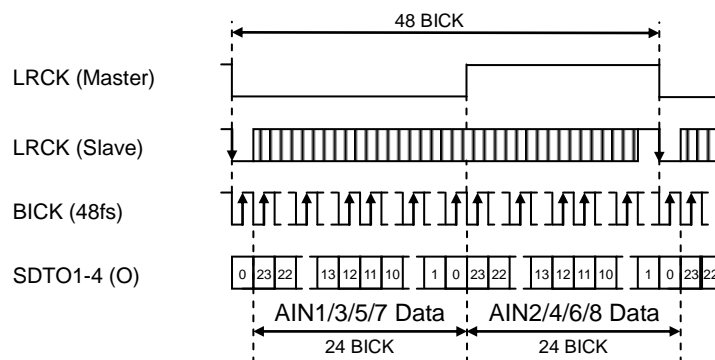

Figure 37. Mode 11/19 Timing (Normal Output, OCT/HEX Speed Mode, I<sup>2</sup>S Compatible, 24-bit)

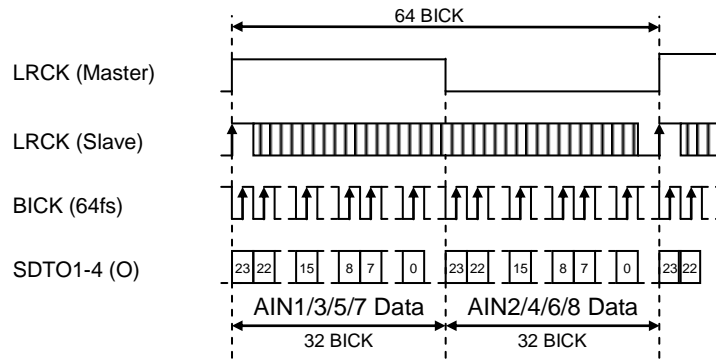

Figure 38. Mode 12/20 Timing (Normal Output, OCT/HEX Speed Mode, MSB Justified, 24-bit)

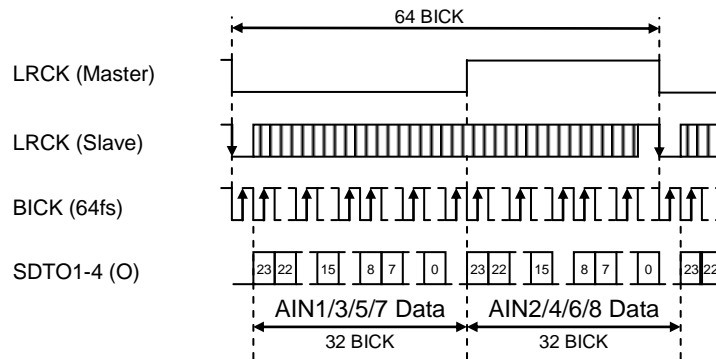

Figure 39. Mode 13/21 Timing (Normal Output, OCT/HEX Speed Mode, I<sup>2</sup>S Compatible, 24-bit)

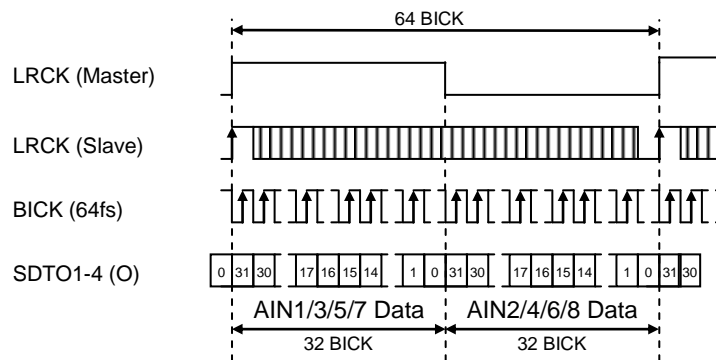

Figure 40. Mode 14/22 Timing (Normal Output, OCT/HEX Speed Mode, MSB Justified, 32-bit)

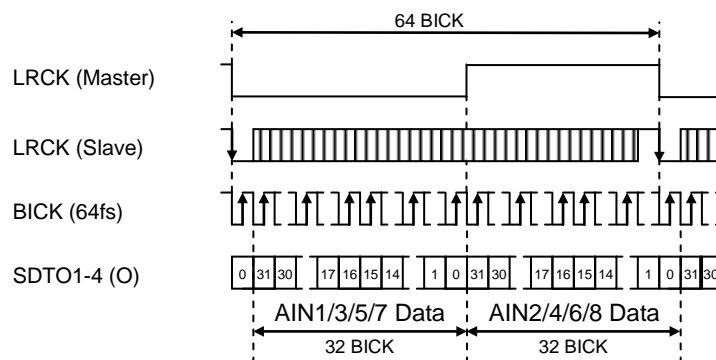

Figure 41. Mode 15/23 Timing (Normal Output, OCT/HEX Speed Mode, I<sup>2</sup>S Compatible, 32-bit)



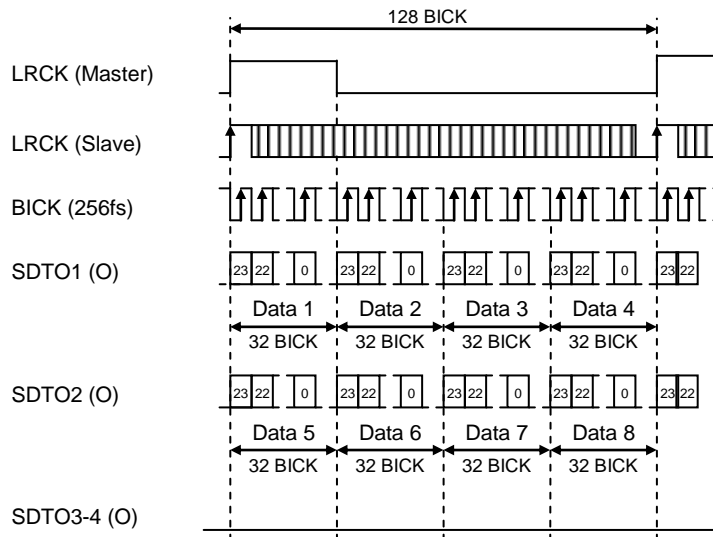

Figure 42. Mode 24/28 Timing (TDM128 Mode, MSB Justified, 24-bit)

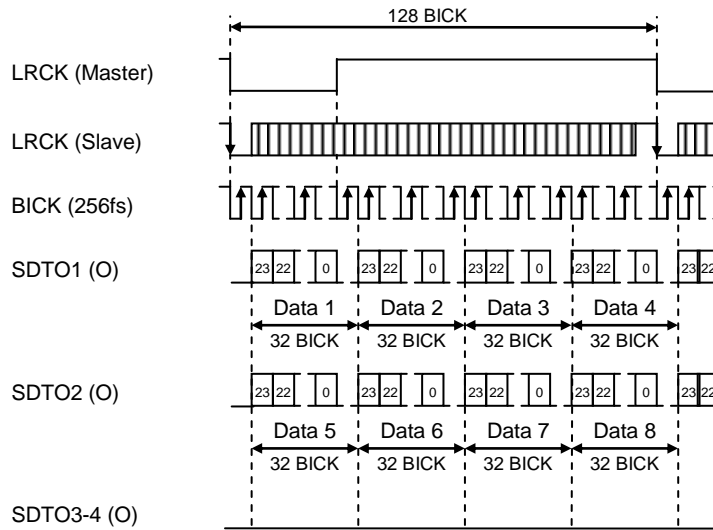

Figure 43. Mode 25/29 Timing (TDM128 Mode, I<sup>2</sup>S Compatible)

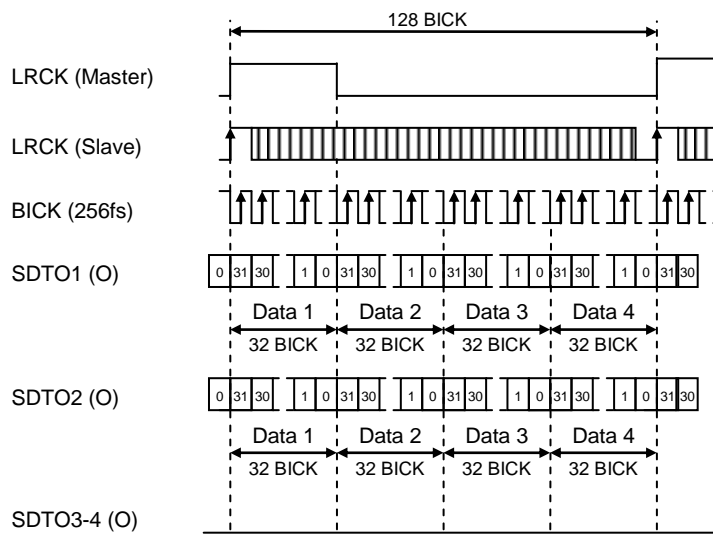

Figure 44. Mode 26/30 Timing (TDM128 Mode, MSB Justified)

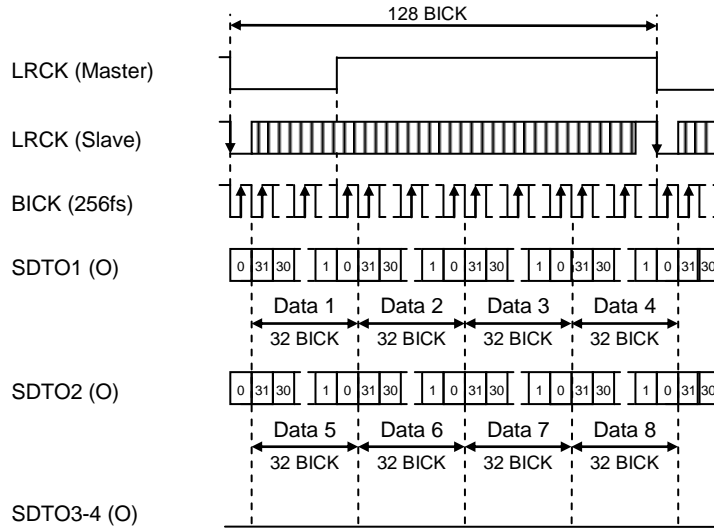

Figure 45. Mode 27/31 Timing (TDM128 Mode, I<sup>2</sup>S Compatible)

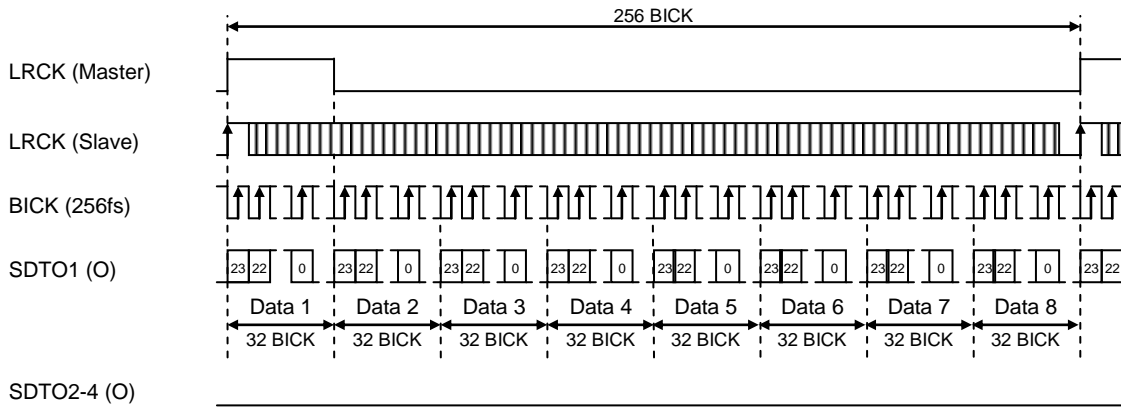

Figure 46. Mode 32/36 Timing (TDM256 Mode, MSB Justified, 24-bit)

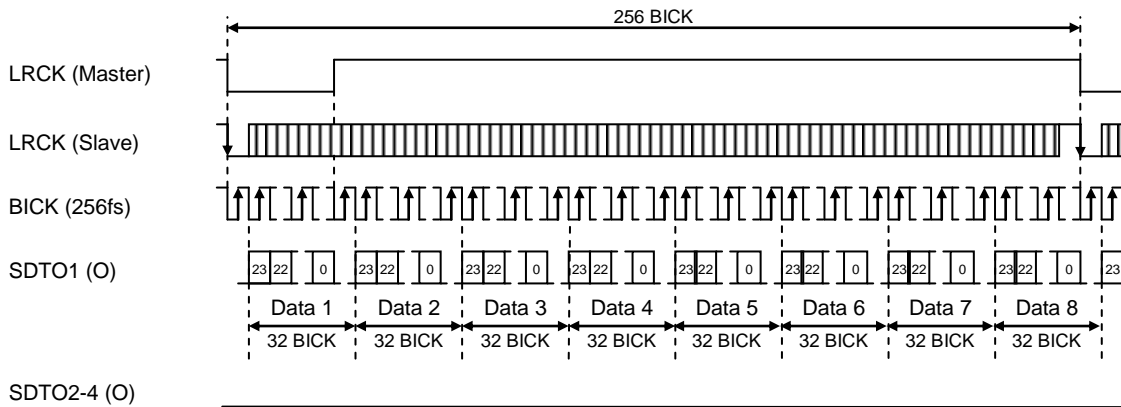

Figure 47. Mode 33/37 Timing (TDM256 Mode, I<sup>2</sup>S Compatible, 24-bit)

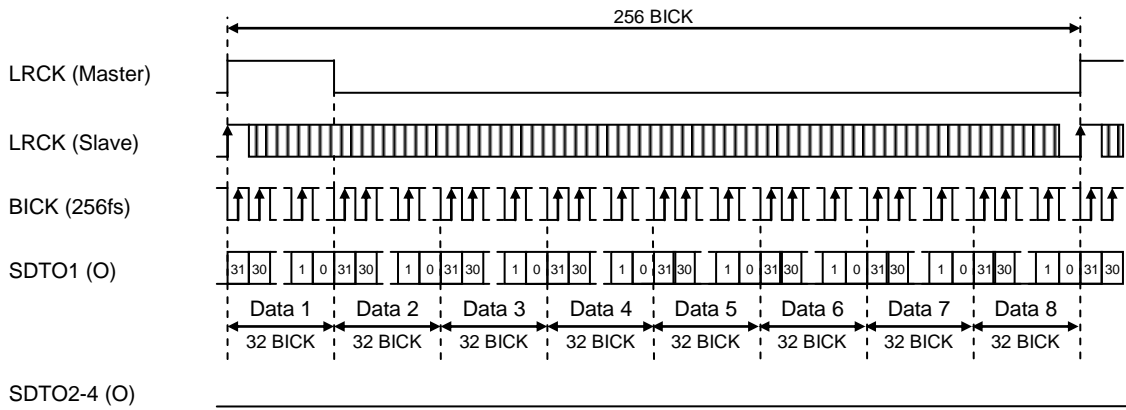

Figure 48. Mode 34/38 Timing (TDM256 Mode, MSB Justified, 32-bit)

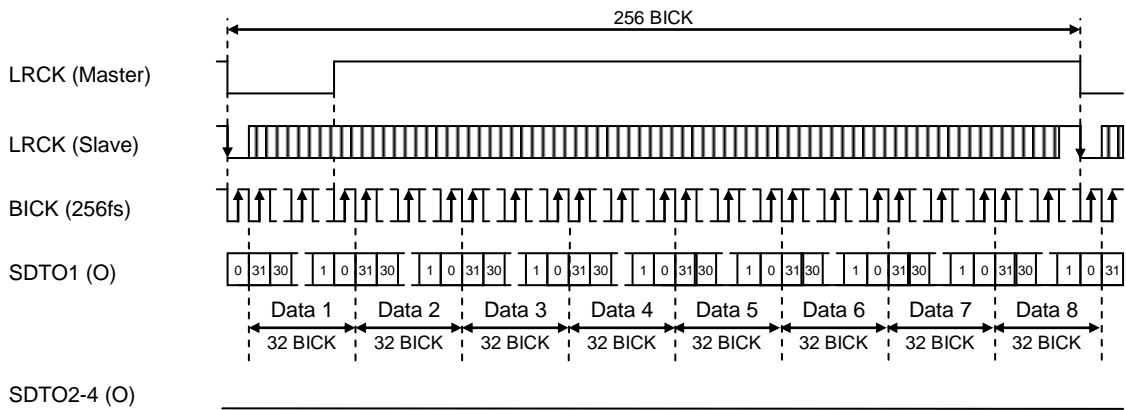

Figure 49. Mode 35/39 Timing (TDM256 Mode, I<sup>2</sup>S Compatible, 32-bit)

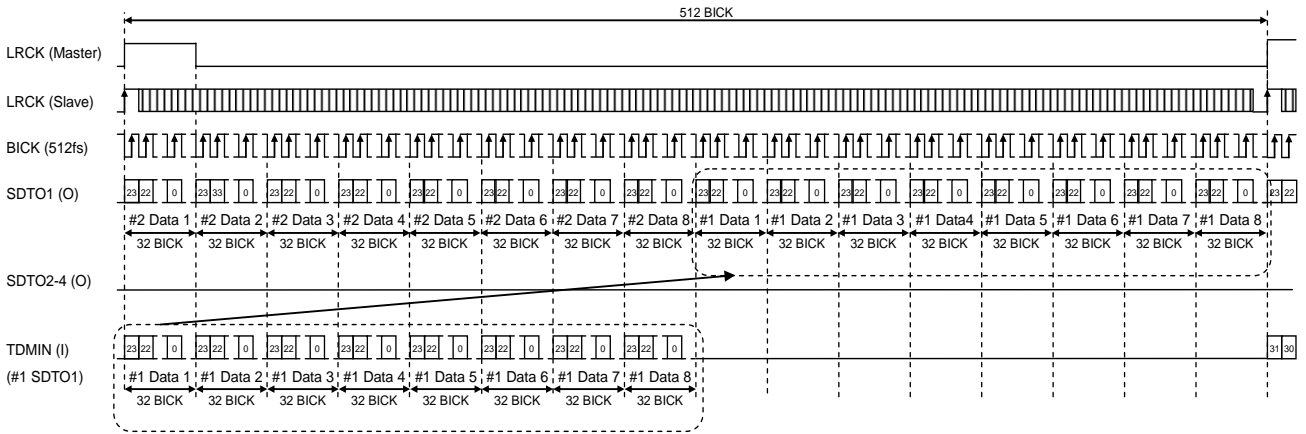

Figure 50. Mode 40/44 Timing (TDM512 Mode, MSB Justified, 24-bit)

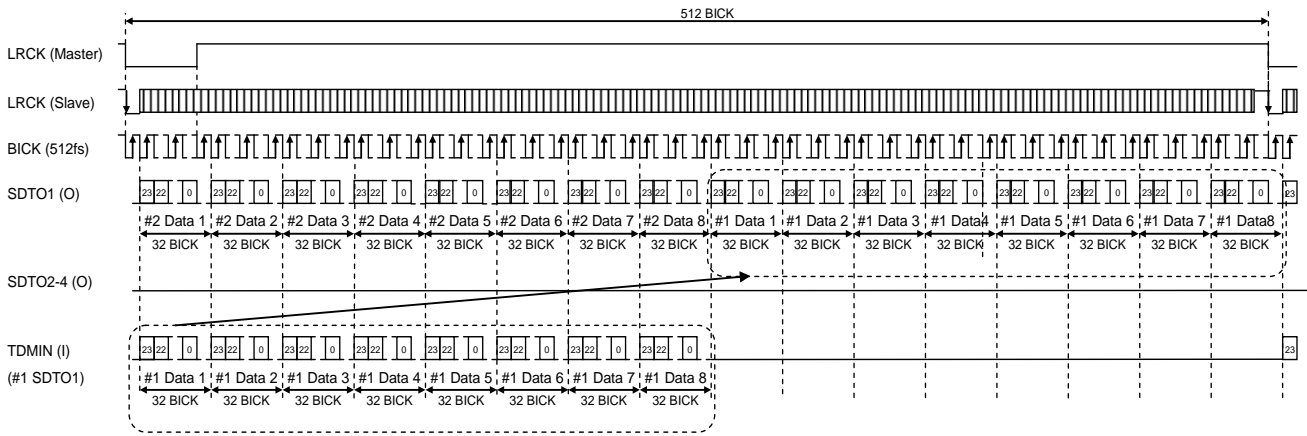

Figure 51. Mode 41/45 Timing (TDM512 Mode, I<sup>2</sup>S Compatible, 24-bit)

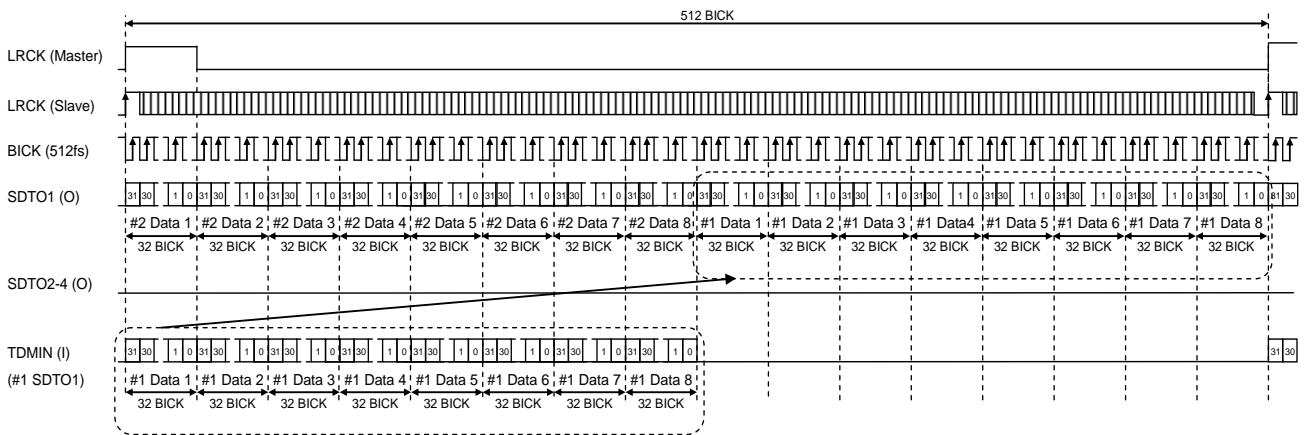

Figure 52. Mode 42/46 Timing (TDM512 Mode, MSB Justified, 32-bit)

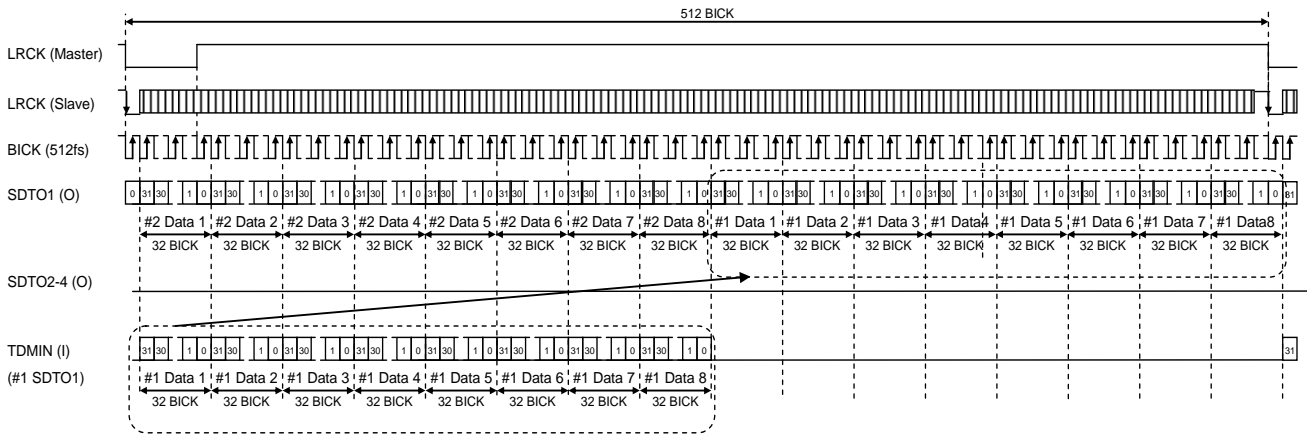

Figure 53. Mode 43/47 Timing (TDM512 Mode, I<sup>2</sup>S Compatible, 32-bit)

Parameter	Symbol	Min.	Typ.	Max.	Unit
MCLK “↑” to BICK “↓”	tMCB	10			ns
BICK “↓” to MCLK “↑”	tBIM	10			ns

Table 10. TDM Mode Clock Timing

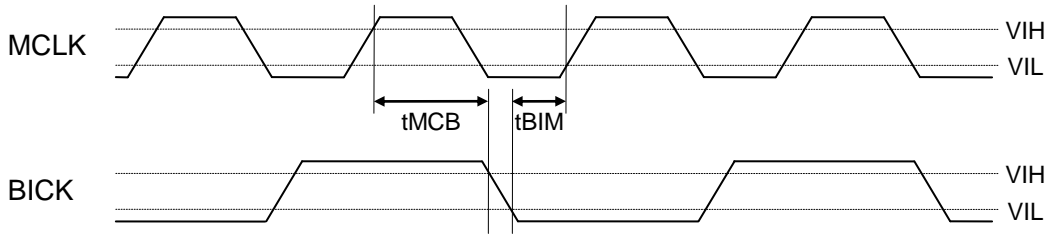

Figure 54. Audio Interface Timing (Slave mode, TDM mode, MCLK=2xBICK)

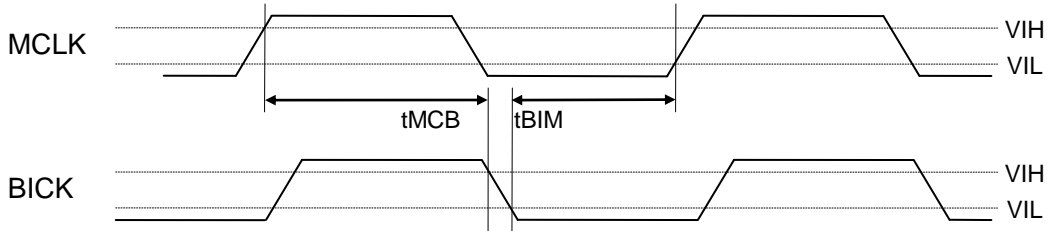

Figure 55. Audio Interface Timing (Slave Mode, TDM Mode, MCLK=BICK)

[2] DSD Mode

DSD output is available only when the AK5578 is in Master mode.

The DCLK frequency can be selected from 64fs, 128fs and 256fs by setting the DSDSEL1-0 pins (bits). The AK5578 enters Phase Modulation mode by setting PMOD pin = "H" or PMOD bit = "1". It does not support Phase Modulation mode when the DCLK frequency is 256fs. DCKB bit controls DCLK polarity.

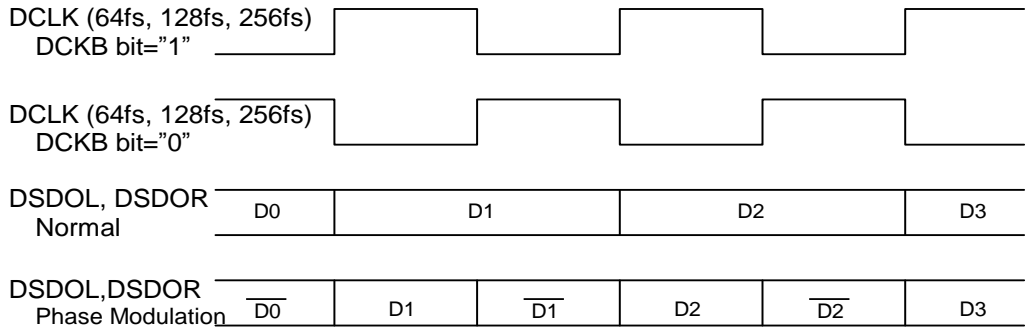

Figure 56. DSD Mode Timing

### ■ Channel Summation (PCM Mode, DSD Mode)

Channel Summation function improves the dynamic range and S/N performance by averaging all A/D data of multiple-channel that the same signal is input. The AK5578 supports 8-to-4 mode, 8-to-2 mode, 8-to-1 mode.

#### 8-to-4 mode (2-Stereo mode)

Improve the dynamic range and S/N for 3 dB (1.5 dB in DSD mode) by averaging two channels.

#### 8-to-2 mode (Stereo mode)

Improve the dynamic range and S/N for 6 dB (3.0 dB in DSD mode) by averaging four channels.

#### 8-to-1 mode (Mono mode)

Improve the dynamic range and S/N for 9 dB (4.5 dB in DSD mode) by averaging eight channels.

#### Not-Summation mode (4-Stereo mode)

Normal mode that does not execute Summation is called as Not-Summation mode or 4-Stereo mode.

Refer to the section “CH Power Down & Channel Summation mode” for details.

### ■ Optimal Data Placement (PCM Mode, DSD Mode)

Assigned data to the SDTO1-4 slot is controlled by the ODP pin setting in parallel control mode.

When the ODP pin = “L”, the data is output by Fixed Data Placement mode. Channel assignment of data slot is fixed regardless of enable/disable of channel summation. For example, averaging data of two channels are output to both channel slots.

When the ODP pin = “H”, the data is output by Optimal Data Placement mode that uses data slot more efficiently. In Optimal Data Placement mode, there are no data redundant of channel summation, and the data is output in MSB justified. Therefore, the maximum number of connecting device in cascade connection will be increased.

If the AK5578 is set to 8-to-4 mode (2-Stereo Mode), two devices can be connected in TDM256 mode, four devices can be connected in TDM512 mode.

If the AK5578 is set to 8-to-2 mode (Stereo Mode), two devices can be connected in TDM128 mode, four devices can be connected in TDM256 mode and eight devices can be connected in TDM512 mode.

If the AK5578 is set to 8-to-1 mode (Mono Mode), four devices can be connected in TDM128 mode, eight devices can be connected in TDM256 mode and sixteen devices can be connected in TDM512 mode.

In serial control mode, the data output is Optimal Data Placement mode regardless of the ODP pin setting.

Refer to “CH Power Down & Channel Summation mode” for details.

## ■ CH Power Down & Channel Summation Setting (PCM Mode, DSD Mode)

### [1] Parallel Control Mode

The setting of the PW2-0 pins and the ODP pin controls the channel power-down and channel summation mode setting in parallel mode (Table 11-Table 16). The PDN pin must be set to “L” when changing the ODP pin and the PW2-0 pins. The power consumption of the device can be improved by setting unused channels to power-down state. In this case, the channel circuit that is powered down will be reset.

When the ODP pin = “L”, the PW2-0 pins control channel power-down and 8-to-4 mode. In this mode, AIN1 and AIN2 channel data are summed digitally and output from the SDTO1 (DSDOL1 and DSDOR1) by dividing into half amplitude. In the same manner, AIN3 and AIN4 channel data are summed digitally and output from the SDTO2 (DSDOL2 and DSDOR2) by dividing into half amplitude. AIN5 and AIN6 channel data are summed digitally and output from the SDTO3 (DSDOL3 and DSDOR3) by dividing into half amplitude. AIN7 and AIN8 channel data are summed digitally and output from the SDTO4 (DSDOL4 and DSDOR4) by dividing into half amplitude.

PW2 pin	PW1 pin	PW0 pin	Power ON/OFF							
			Ch8	Ch7	Ch6	Ch5	Ch4	Ch3	Ch2	Ch1
L	L	L	OFF	OFF	OFF	OFF	OFF	OFF	OFF	OFF
L	L	H	ON	ON	OFF	OFF	ON	ON	ON	ON
L	H	L	OFF	OFF	ON	ON	ON	ON	ON	ON
L	H	H	ON	ON	ON	ON	ON	ON	ON	ON
H	L	L	OFF	ON	ON	ON	ON	ON	ON	ON
H	L	H	ON	ON	OFF	OFF	ON	ON	ON	ON
H	H	L	OFF	OFF	ON	ON	ON	ON	ON	ON
H	H	H	ON	ON	ON	ON	ON	ON	ON	ON

Table 11. Channel Power ON/OFF (Parallel Control Mode, ODP pin= “L”)

PW2 pin	PW1 pin	PW0 pin	Data on Slot							
			Slot 8	Slot 7	Slot 6	Slot 5	Slot 4	Slot 3	Slot 2	Slot 1
L	L	L	All “0”	All “0”	All “0”	All “0”	All “0”	All “0”	All “0”	All “0”
L	L	H	(CH7+8) /2	(CH7+8) /2	All “0”	All “0”	(CH3+4) /2	(CH3+4) /2	(CH1+2) /2	(CH1+2) /2
L	H	L	All “0”	All “0”	(CH5+6) /2	(CH5+6) /2	(CH3+4) /2	(CH3+4) /2	(CH1+2) /2	(CH1+2) /2
L	H	H	(CH7+8) /2	(CH7+8) /2	(CH5+6) /2	(CH5+6) /2	(CH3+4) /2	(CH3+4) /2	(CH1+2) /2	(CH1+2) /2
H	L	L	All “0”	CH7	CH6	CH5	CH4	CH3	CH2	CH1
H	L	H	CH8	CH7	All “0”	All “0”	CH4	CH3	CH2	CH1
H	H	L	All “0”	All “0”	CH6	CH5	CH4	CH3	CH2	CH1
H	H	H	CH8	CH7	CH6	CH5	CH4	CH3	CH2	CH1

Table 12. Slot Data Assign (Parallel Control Mode, ODP pin= “L”)

When the ODP pin = “H”, the AK5578 becomes optimal data placement mode and data slots can be used efficiently. The PW2-0 pins control power down, 8-to-4 mode, 8-to-2 mode and 8-to-1 mode.

In 8-to-4 mode, AIN1 and AIN2 channel data are summed digitally and output from the SDTO1 (DSDOL1) of the slot1 by dividing into half amplitude. In the same manner, AIN3 and AIN4 channel data are summed digitally and output from the SDTO1 (DSDOR1) of the slot2 by dividing into half amplitude. AIN5 and AIN6 channel data are summed digitally and output from the SDTO2 (DSDOL2) of the slot3 by dividing into half amplitude. AIN7 and AIN8 channel data are summed digitally and output from the SDTO2 (DSDOR2) of the slot4 by dividing into half amplitude.

In 8-to-2 mode, AIN1 - AIN4 channel data are summed digitally and output from the SDTO1 (DSDOL1) of the slot1 by dividing into quarter amplitude. AIN5 - AIN8 channel data are summed digitally and output

from the SDTO1 (DSDOR1) of the slot2 by dividing into quarter amplitude.

In 8-to-1 mode, AIN1 – AIN8 channel data are summed digitally and output from the SDTO1 (DSDOL1) of the slot1 by dividing into 1/8 amplitude

PW2 pin	PW1 pin	PW0 pin	Power ON/OFF							
			Ch8	Ch7	Ch6	Ch5	Ch4	Ch3	Ch2	Ch1
L	L	L	OFF	OFF	OFF	OFF	OFF	OFF	OFF	OFF
L	L	H	ON	ON	ON	ON	ON	ON	ON	ON
L	H	L	ON	ON	ON	ON	ON	ON	ON	ON
L	H	H	ON	ON	ON	ON	ON	ON	ON	ON
H	L	L	ON	ON	ON	ON	ON	ON	ON	ON
H	L	H	ON	ON	ON	ON	ON	ON	ON	ON
H	H	L	ON	ON	ON	ON	ON	ON	ON	ON
H	H	H	ON	ON	ON	ON	ON	ON	ON	ON

Table 13. Channel Power ON/OFF (Parallel Control Mode, ODP pin= "H")

PW2 pin	PW1 pin	PW0 pin	Data on Slot							
			Slot 8	Slot 7	Slot 6	Slot 5	Slot 4	Slot 3	Slot 2	Slot 1
L	L	L	All "0"	All "0"	All "0"	All "0"	All "0"	All "0"	All "0"	All "0"
L	L	H	All "0"	All "0"	All "0"	All "0"	All "0"	All "0"	(CH5+6 7+8)/4	(CH1+2 +3+4)/4
L	H	L	All "0"	All "0"	All "0"	All "0"	(CH7+8) /2	(CH5+6) /2	(CH3+4) /2	(CH1+2) /2
L	H	H	All "0"	All "0"	All "0"	All "0"	All "0"	All "0"	All "0"	(CH1+2+ 3+4+5+6 +7+8)/8
H	L	L	CH8	CH7	CH6	CH5	CH4	CH3	CH2	CH1
H	L	H	All "0"	All "0"	All "0"	All "0"	All "0"	All "0"	(CH5+6 7+8)/4	(CH1+2 +3+4)/4
H	H	L	All "0"	All "0"	All "0"	All "0"	(CH7+8) /2	(CH5+6) /2	(CH3+4) /2	(CH1+2) /2
H	H	H	All "0"	All "0"	All "0"	All "0"	All "0"	All "0"	All "0"	(CH1+2+ 3+4+5+6 +7+8)/8

Table 14. Slot Data Assign (Parallel Control Mode, ODP pin= "H", Normal Output)



PW2 pin	PW1 pin	PW0 pin	Data on Slot								
			Slot 8	Slot 7	Slot 6	Slot 5	Slot 4	Slot 3	Slot 2	Slot 1	
L	L	L	All "0"	All "0"	All "0"	All "0"	All "0"	All "0"	All "0"	All "0"	All "0"
L	L	H	All "0"	All "0"	All "0"	All "0"	TDMIN	TDMIN	(CH5+6 7+8)/4	(CH1+2 +3+4)/4	
L	H	L	All "0"	All "0"	All "0"	All "0"	(CH7+8) /2	(CH5+6) /2	(CH3+4) /2	(CH1+2) /2	
L	H	H	All "0"	All "0"	All "0"	All "0"	TDMIN	TDMIN	TDMIN	(CH1+2+ 3+4+5+6 +7+8)/8	
H	L	L	CH8	CH7	CH6	CH5	CH4	CH3	CH2	CH1	
H	L	H	All "0"	All "0"	All "0"	All "0"	TDMIN	TDMIN	(CH5+6 7+8)/4	(CH1+2 +3+4)/4	
H	H	L	All "0"	All "0"	All "0"	All "0"	(CH7+8) /2	(CH5+6) /2	(CH3+4) /2	(CH1+2) /2	
H	H	H	All "0"	All "0"	All "0"	All "0"	TDMIN	TDMIN	TDMIN	(CH1+2+ 3+4+5+6 +7+8)/8	

Table 15. Slot Data Assign (Parallel Control Mode, ODP pin= "H", TDM128)

PW2 pin	PW1 pin	PW0 pin	Data on Slot								
			Slot 8	Slot 7	Slot 6	Slot 5	Slot 4	Slot 3	Slot 2	Slot 1	
L	L	L	All "0"	All "0"	All "0"	All "0"	All "0"	All "0"	All "0"	All "0"	All "0"
L	L	H	TDMIN	TDMIN	TDMIN	TDMIN	TDMIN	TDMIN	(CH5+6 7+8)/4	(CH1+2 +3+4)/4	
L	H	L	TDMIN	TDMIN	TDMIN	TDMIN	(CH7+8) /2	(CH5+6) /2	(CH3+4) /2	(CH1+2) /2	
L	H	H	TDMIN	TDMIN	TDMIN	TDMIN	TDMIN	TDMIN	TDMIN	(CH1+2+ 3+4+5+6 +7+8)/8	
H	L	L	CH8	CH7	CH6	CH5	CH4	CH3	CH2	CH1	
H	L	H	TDMIN	TDMIN	TDMIN	TDMIN	TDMIN	TDMIN	(CH5+6 7+8)/4	(CH1+2 +3+4)/4	
H	H	L	TDMIN	TDMIN	TDMIN	TDMIN	(CH7+8) /2	(CH5+6) /2	(CH3+4) /2	(CH1+2) /2	
H	H	H	TDMIN	TDMIN	TDMIN	TDMIN	TDMIN	TDMIN	TDMIN	(CH1+2+ 3+4+5+6 +7+8)/8	

Table 16. Slot Data Assign (Parallel Control Mode, ODP pin= "H", TDM256 &amp; TDM512)

## [2] Serial Control Mode

In 3-wire serial mode or I<sup>2</sup>C mode, PW1-8 bits control the power of AIN1-8 channels independently. AINn channel is powered down when PWn bit = "0" (n=1-8) and AINn channel is in normal operation when PWn bit = "1". The power-down channel is reset status and outputs all "0". The channel summation is controlled by MONO1 and MONO2 bits. RSTN bit must be "0" when changing the setting of MONO1, MONO2 and PW1-8 bits.

MONO2 bit	MONO1 bit	Data on Slot (Normal Output & DSD mode)							
		Slot 8	Slot7	Slot6	Slot 5	Slot 4	Slot 3	Slot 2	Slot 1
0	0	CH8	CH7	CH6	CH5	CH4	CH3	CH2	CH1
0	1	All "0"	All "0"	All "0"	All "0"	All "0"	All "0"	(CH5+6+7+8)/4	(CH1+2+3+4)/4
1	0	All "0"	All "0"	All "0"	All "0"	(CH7+8)/2	(CH5+6)/2	(CH3+4)/2	(CH1+2)/2
1	1	All "0"	All "0"	All "0"	All "0"	All "0"	All "0"	All "0"	(CH1+2+3+4+5+6+7+8)/8

Table 17. Slot Data Assign (Serial Control mode, Normal Output &amp; DSD mode)

MONO2 bit	MONO1 bit	Data on Slot (TDM128)							
		Slot 8	Slot7	Slot6	Slot 5	Slot 4	Slot 3	Slot 2	Slot 1
0	0	CH8	CH7	CH6	CH5	CH4	CH3	CH2	CH1
0	1	All "0"	All "0"	All "0"	All "0"	TDMIN	TDMIN	(CH5+6+7+8)/4	(CH1+2+3+4)/4
1	0	All "0"	All "0"	All "0"	All "0"	(CH7+8)/2	(CH5+6)/2	(CH3+4)/2	(CH1+2)/2
1	1	All "0"	All "0"	All "0"	All "0"	TDMIN	TDMIN	TDMIN	(CH1+2+3+4+5+6+7+8)/8

Table 18. Slot Data Assign (Serial Control Mode, TDM128)

MONO2 bit	MONO1 bit	Data on Slot (TDM256 & TDM512)							
		Slot 8	Slot7	Slot6	Slot 5	Slot 4	Slot 3	Slot 2	Slot 1
0	0	CH8	CH7	CH6	CH5	CH4	CH3	CH2	CH1
0	1	TDMIN	TDMIN	TDMIN	TDMIN	TDMIN	TDMIN	(CH5+6+7+8)/4	(CH1+2+3+4)/4
1	0	TDMIN	TDMIN	TDMIN	TDMIN	(CH7+8)/2	(CH5+6)/2	(CH3+4)/2	(CH1+2)/2
1	1	TDMIN	TDMIN	TDMIN	TDMIN	TDMIN	TDMIN	TDMIN	(CH1+2+3+4+5+6+7+8)/8

Table 19. Slot Data Assign (Serial Control Mode, TDM256 &amp; TDM512)

■ Data Slot Configuration

[1] PCM Mode

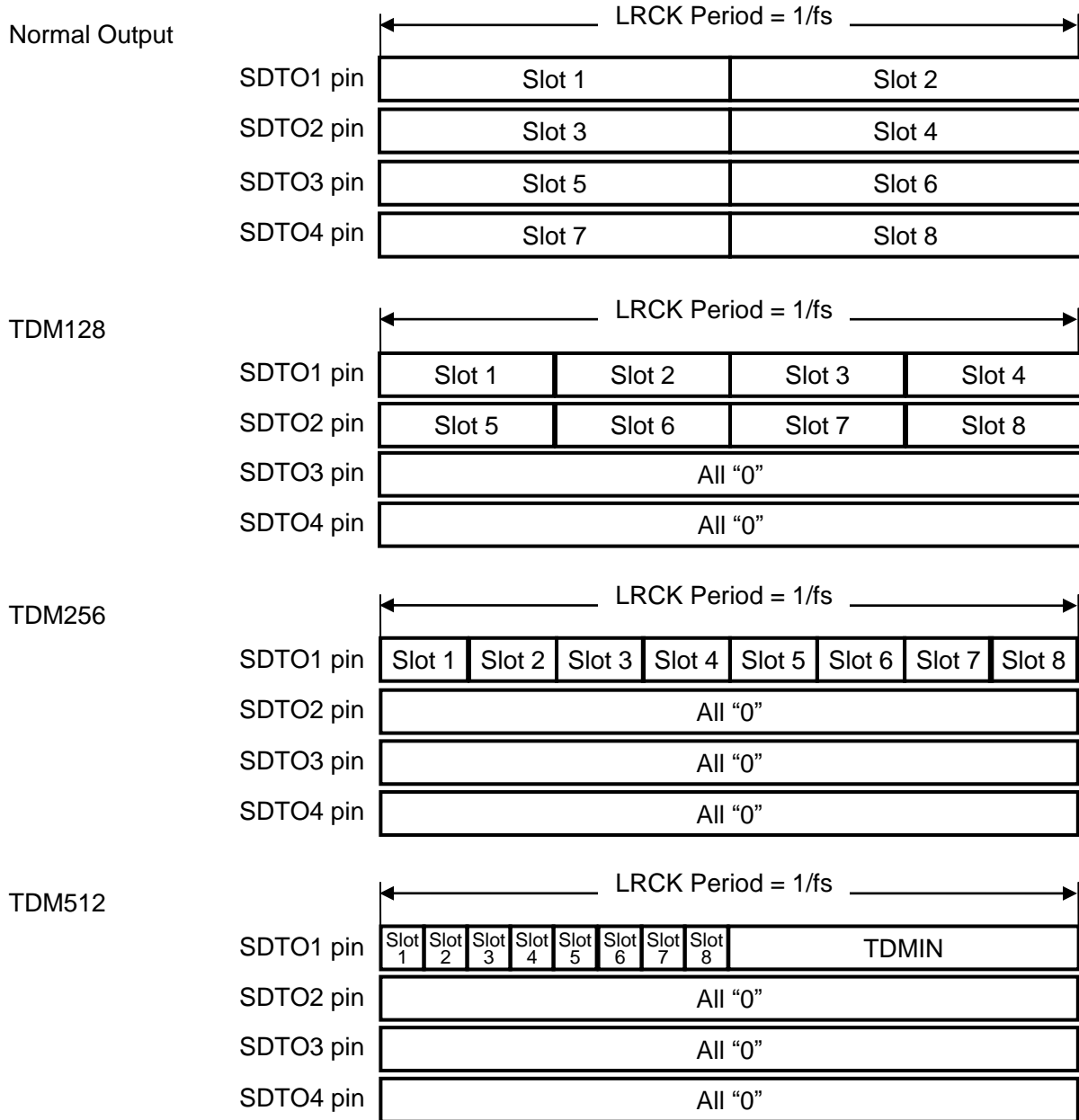

Figure 57. Slot Assign in PCM Mode

[2] DSD Mode

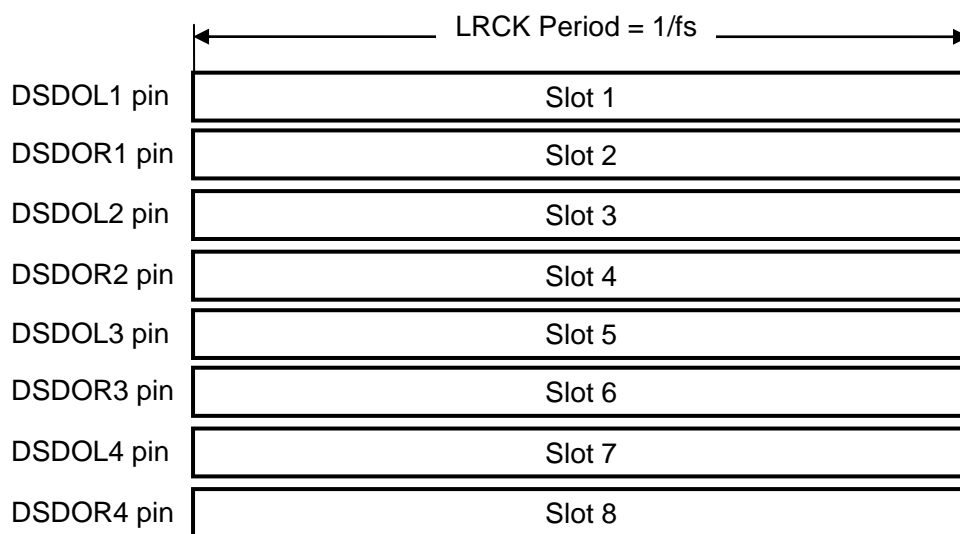

Figure 58. Slot Assign in DSD Mode

### ■ Digital Filter Setting (PCM Mode)

The AK5578 has four types of digital filters and they can be selected by SD pin (bit) and SLOW pin (bit). The filter setting is not available in OCT speed mode, HEX speed mode and DSD mode. So the setting of the digital filter is ignored.

SD pin (bit)	SLOW pin (bit)	Filter
L (0)	L (0)	Sharp Roll-off Filter
L (0)	H (1)	Slow Roll-off Filter
H (1)	L (0)	Short Delay Sharp Roll-off Filter
H (1)	H (1)	Short Delay Slow Roll-off Filter

Table 20. Digital Filter Setting

### ■ Digital HPF (PCM Mode)

The AK5578 has a digital high-pass filter for DC offset cancellation. The digital high-pass filter is enabled by setting the HPFE pin (bit) = "H (1)". The cut-off frequency of the high-pass filter is fixed 1.0 Hz when  $f_s = 48$  kHz (Normal Speed mode), 96 kHz (Double Speed mode) or 192 kHz (Quad Speed mode). The high-pass filter is not available in OCT speed mode, HEX speed mode and DSD mode. So that the setting of the HPFE pin is ignored. The high pass-filter setting should be changed when all channels are reset condition.

### ■ Overflow Detection (PCM Mode, DSD Mode)

#### [1] PCM Mode

The AK5578 has an overflow detect function for the analog input.

The OVF pin outputs "H" if one of AIN1 - 8 channels overflows (more than  $-0.3$  dBFS). The OVF pin returns to "L" when analog input overflows are resolved. The OVF output for overflowed analog input has the same group delay as the ADC.

#### [2] DSD Mode

Overflow Detection (Error Detection Function)

The OVF pin outputs "H" if any channel's DSD modulators overflows. The OVF pin returns to "L" when overflows are resolved.

## ■ LDO

The voltage range of TVDD is from 1.7 V to 1.98 V or from 3.0 V to 3.6 V. Set ON/OFF of the LDO by the LDOE pin according to TVDD voltage (Table 21).

The internal LDO is switched ON/OFF depending on TVDD voltage range.

LDOE	PDN	LDO	VDD18 pin	Additional Voltage Range to TVDD pin
L	L	OFF	External Power Input 1.7-1.98 V	1.7-1.98 V
L	H	OFF	External Power Input 1.7-1.98 V	1.7-1.98 V
H	L	OFF	Pulled Down by 500 $\Omega$ internally	3.0-3.6 V
H	H	ON	LDO Voltage Output	3.0-3.6 V

Table 21. LDO Control

[1] TVDD=1.7-1.98 V, LDO is OFF (LDOE pin = "L")

The internal LDO does not work properly when the TVDD voltage range is from 1.7 V to 1.98 V. Set the LDOE pin to "L" to switch OFF the LDO. A 1.7 V - 1.98 V is supplied from the VDD18 pin for internal logic circuits. The voltage difference between TVDD and VDD18 must be  $\pm 0.1$  V or less.

[2] TVDD=3.0-3.6 V, LDO is ON (LDOE pin = "H")

The internal LDO should be ON when the TVDD voltage range is from 3.0 V to 3.6 V. It will be the power supply for the internal logic circuit. The VDD18 pin will be a connection terminal for a stabilization capacitor. It is not possible to supply the power to external circuits from the VDD18 pin.

## ■ Reset

The AK5578 must be reset upon power up or when changing the clock setting or clock frequency. It can be reset by the PDN pin or PW2-0 pins and RSTN bit or PW8-1 bits.

## ■ Power Up/Down Sequence

The AK5578 enters power-down mode by setting the PDN pin to “L”. Digital filters are reset at the same time.

### [1] PCM Mode

In slave mode, internal power down signal (Internal PDN) is released by inputting MCLK, BICK and LRCK after setting the PDN pin to “H”. In master mode, The Internal PDN is released by inputting MCLK after setting the PDN pin to “H”.

Initialization cycle starts when the Internal PDN is released. The output data of SDTO will be valid in  $583 \times 1/f_s$  after exiting power-down mode in slave mode, it will be valid in  $578 \times 1/f_s$  after exiting power-down mode in master mode. During initialization, the ADC digital outputs of both channels are in 2's complement format and forced to “0”. The ADC outputs settle to data correspondent to the input signals after the end of initialization. This settling takes approximately the group delay time.

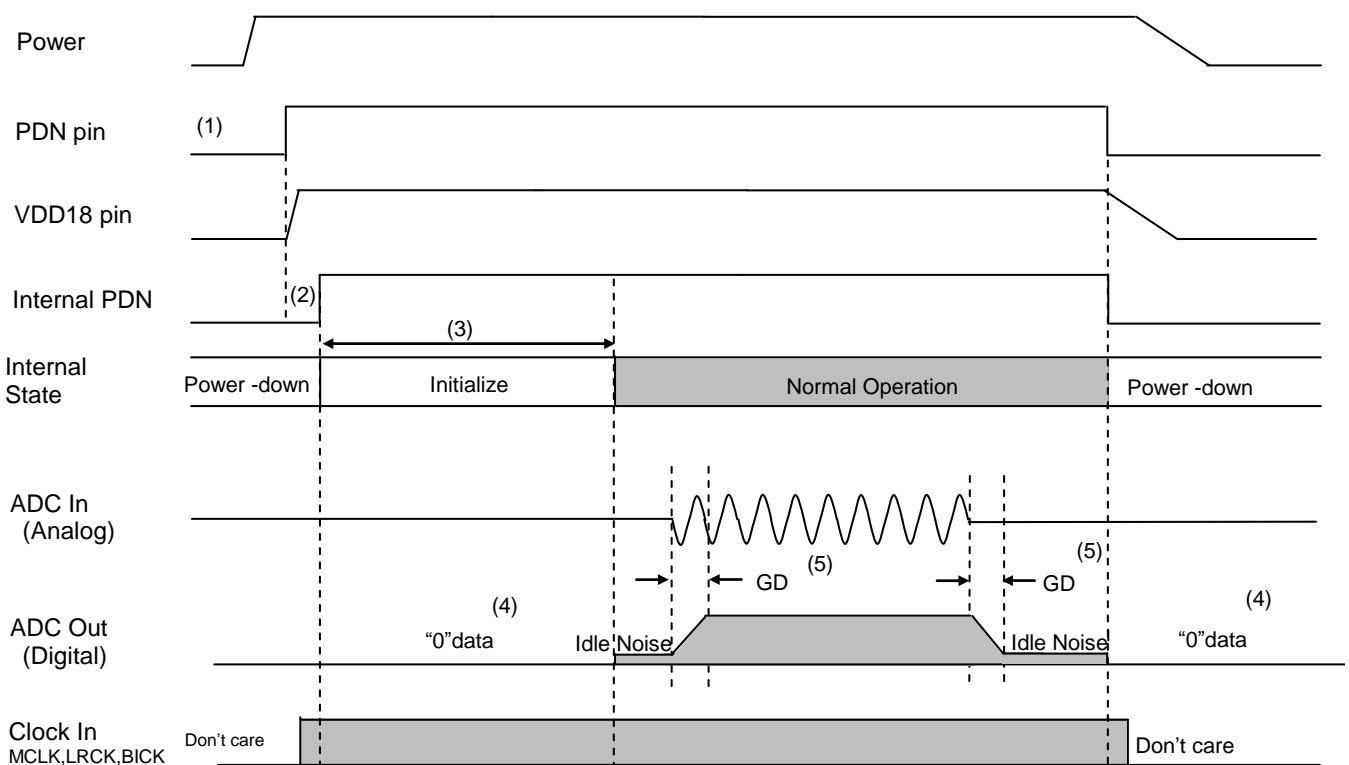

Figure 59. Power-Up/Down Sequence Example

### Notes

- (1) The PDN pin should be held to “L” for more than 150 ns after AVDD and TVDD are powered up.
- (2) a. LDEO pin = “H”, I2C pin = “H” and PSN pin = “H” (Parallel Mode):  
The internal LDO is powered up by releasing PDN pin to “H”. The Internal PDN is released by toggling MCLK for 16384 times.
- b. LDOE pin = “H” and PSN pin = “L” (Register Mode):  
The internal LDO is powered up by releasing PDN pin to “H”. The internal PDN is released by toggling internal oscillator clock for 16384 times (max. 10 ms).
- c. LDOE pin = “L”:  
The internal PDN is released in 1 ms (max.) after releasing PDN pin to “H”.  
During this period, digital output and digital in/output pins may output an instantaneous pulse (max. 1 us). Therefore, referring the output of digital pins and data transmission with a device on the same 3-wire serial/I<sup>2</sup>C bus as the AK5578 should be avoided in this period to prevent system errors.
- (3) Initialization cycle is  $583/f_s$  in slave mode and  $578/f_s$  in master mode.
- (4) The ADC output data is “0” during initialization cycle and power-down mode.
- (5) The digital output corresponding to analog input has group delay (GD).

Internal PDN Release Sequence

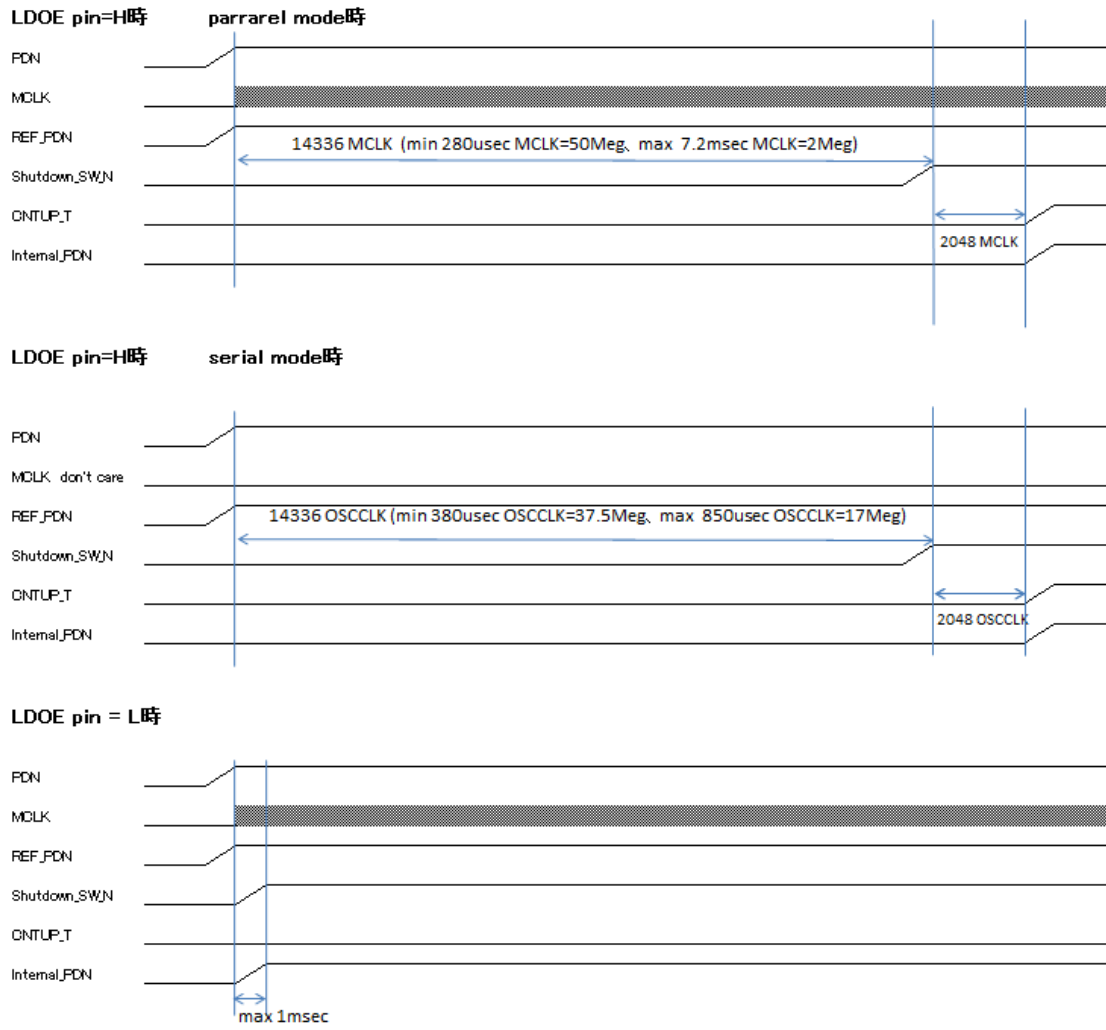

Figure 60. Internal PDN Release Sequence



## [2] DSD mode

The Internal PDN is released by inputting MCLK after setting the PDN pin to "H".

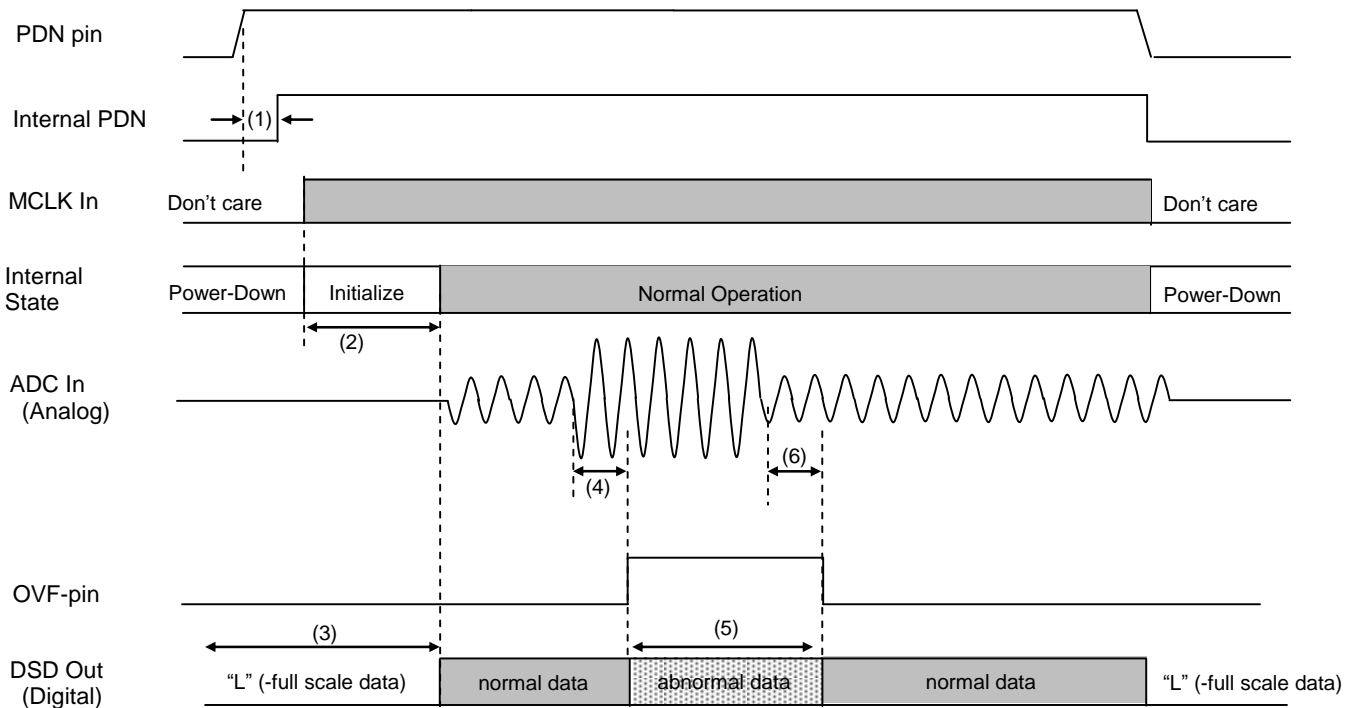

Figure 61. DSD Operation Timing

## Notes:

- (1) The internal LDO is powered up by releasing PDN pin to "H". The internal PDN is released by toggling internal oscillator clock for 16384 times (max. 10ms). The internal PDN is released in max. 1 ms after releasing PDN pin to "H". Register writings become available when the internal PDN changes to "1". During this period, digital output and digital in/output pins may output an instantaneous pulse (max. 1  $\mu$ s). Therefore, referring the output of digital pins and data transmission with a device on the same 3-wire serial/I<sup>2</sup>C bus as the AK5578 should be avoided in this period to prevent system errors.
- (2) Initialization operation will be completed in 583/fs.
- (3) DSD output pins output "L" (-full scale data) during power down and initializing operation. DSD output pins output full scale data during phase modulation mode, a reset sequence and a CH power down status.
- (4) The OVF pin outputs "H" when an excessive signal is input and overflow is detected at internal modulator.
- (5) In the case above (4), the DSD output data will not be correct.
- (6) The OVF pin returns to "L" when the input signal settled to a normal state and overflow status of the internal modulator is resolved.

## ■ Operation Mode Control

Operation modes of the AK5578 are set by pins or registers. In parallel control mode, the operation mode is set by pin and register settings are invalid. Therefore the functions that need register settings are not available in parallel control mode. For register accessing, 3-wire serial and I<sup>2</sup>C bus communications are available. This control mode of the AK5578 is selected by the I2C pin and the PSN pin. In serial control mode, register settings are prioritized so that all pin settings except the MSN pin setting are ignored.

I2C pin	PSN pin	Control mode
L	L	3-wire Serial
L	H	3-wire Serial
H	L	I <sup>2</sup> C Bus
H	H	Parallel

Table 22. Control mode

## ■ Register Control Interface

### (1) 3-wire Serial Control Mode (I2C pin = "L")

The internal registers may be written through the 3-wire  $\mu$ P interface pins (CSN, CCLK and CDTI). The data on this interface consists of a 2-bit Chip address, Read/Write (1bit, Fixed to "1", Write only), Register address (MSB first, 5bits) and Control data (MSB first, 8bits). Address and data are clocked in on the rising edge of CCLK and data is clocked out on the falling edge. For write operations, data is latched after a low-to-high transition of CSN. The clock speed of CCLK is 5MHz (max).

The internal registers are initialized by setting the PDN pin = "L". In serial control mode, an internal timing circuit is reset by setting RSTN bit = "0" but register values are not initialized.

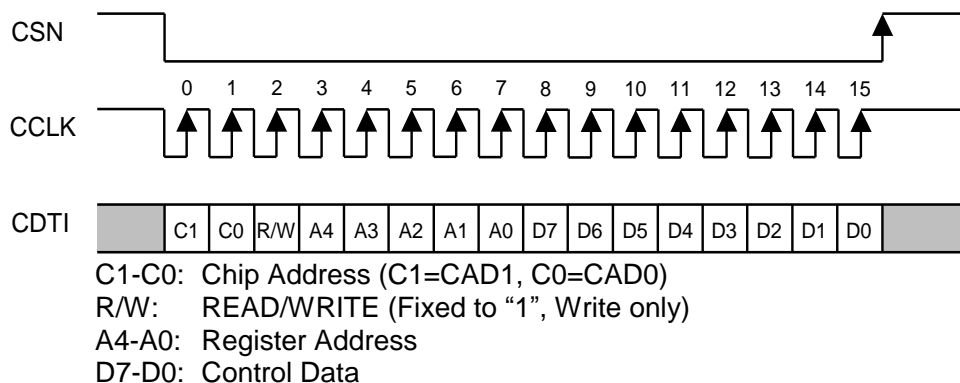

Figure 62. Control I/F Timing

- \* The AK5578 does not support read commands in 3-wire serial control mode.
- \* When the AK5578 is in power down mode (PDN pin = "L"), a writing into the control registers is prohibited.
- \* The control data cannot be written when the CCLK rising edge is 15 times or less, or 17 times or more during CSN is "L".

(2) I<sup>2</sup>C-bus Control Mode (I2C pin = “H” and PSN pin = “L”)  
 The AK5578 supports the fast-mode I2C-bus (max: 400 kHz, Ver1.0).

(2)-1. WRITE Operations

Figure 63 shows the data transfer sequence of the I2C-bus control mode. All commands are preceded by a START condition. A HIGH to LOW transition on the SDA line while SCL is HIGH indicates a START condition (Figure 69). After the START condition, a slave address is sent. This address is 7 bits long followed by the eighth bit that is a data direction bit (R/W). The most significant five bits of the slave address are fixed as “00100”. The next bits are CAD1-0 (device address bits). This bits identifies the specific device on the bus. The hard-wired input pins (CAD1-0 pins) set these device address bit (Figure 64). If the slave address matches that of the AK5578, the AK5578 generates an acknowledge and the operation is executed. The master must generate the acknowledge-related clock pulse and release the SDA line (HIGH) during the acknowledge clock pulse (Figure 70). R/W bit = “1” indicates that the read operation is to be executed. “0” indicates that the write operation is to be executed.

The second byte consists of the control register address of the AK5578. The format is MSB first, and those most significant 3-bits are fixed to zeros (Figure 65). The data after the second byte contains control data. The format is MSB first, 8bits (Figure 66). The AK5578 generates an acknowledge after each byte is received. Data transfer is always terminated by a STOP condition generated by the master. A LOW to HIGH transition on the SDA line while SCL is HIGH defines STOP condition (Figure 69).

The AK5578 can perform more than one byte write operation per sequence. After receipt of the third byte the AK5578 generates an acknowledge and awaits the next data. The master can transmit more than one byte instead of terminating the write cycle after the first data byte is transferred. After receiving each data packet the internal 6-bit address counter is incremented by one, and the next data is automatically taken into the next address. If the address exceeds “07H” prior to generating a stop condition, the address counter will “roll over” to “00H” and the previous data will be overwritten.

The data on the SDA line must remain stable during the HIGH period of the clock. The HIGH or LOW state of the data line can only change when the clock signal on the SCL line is LOW (Figure 71) except for the START and STOP conditions.

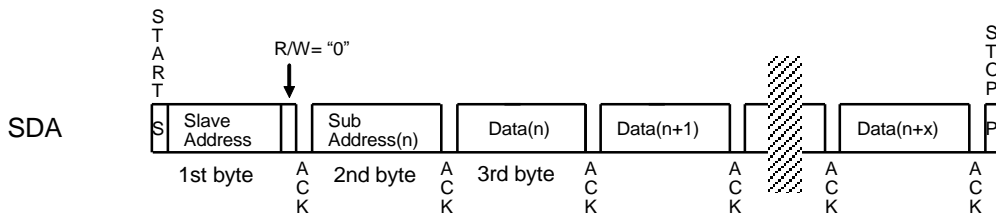
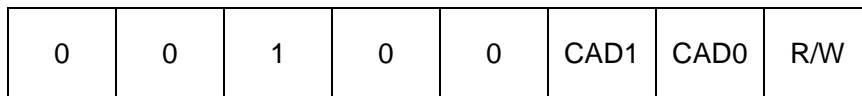

Figure 63. Data Transfer Sequence at the I<sup>2</sup>C-Bus Control Mode



(CAD0 and CAD1 are set by pins)

Figure 64. The First Byte

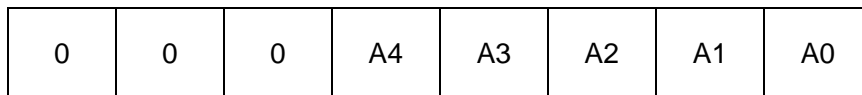

Figure 65. The Second Byte

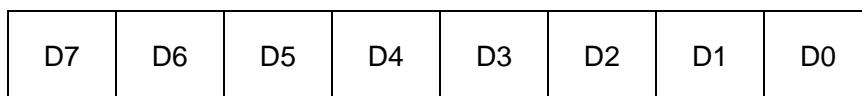

Figure 66. Byte Structure After The Second Byte

(2)-2. READ Operations

Set the R/W bit = "1" for the READ operation of the AK5578. After transmission of data, the master can read the next address's data by generating an acknowledge instead of terminating the write cycle after the receipt of the first data word. After receiving each data packet the internal 6-bit address counter is incremented by one, and the next data is automatically taken into the next address. If the address exceeds "07H" prior to generating stop condition, the address counter will "roll over" to "00H" and the data of "00H" will be read out.

The AK5578 supports two basic read operations: Current Address Read and Random Address Read.

(2)-2-1. Current Address Read

The AK5578 contains an internal address counter that maintains the address of the last word accessed, incremented by one. Therefore, if the last access (either a read or write) was to address "n", the next CURRENT READ operation would access data from the address "n+1". After receipt of the slave address with R/W bit "1", the AK5578 generates an acknowledge, transmits 1-byte of data to the address set by the internal address counter and increments the internal address counter by 1. If the master does not generate an acknowledge but generates a stop condition instead, the AK5578 ceases transmission.

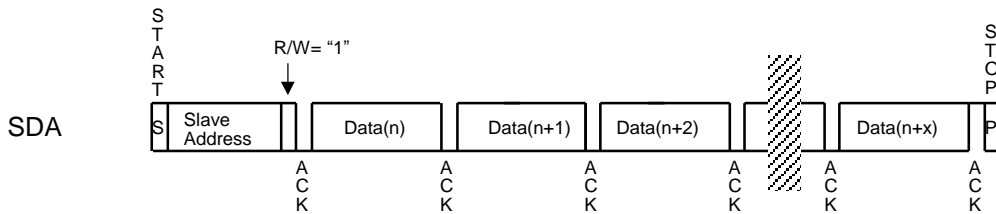

Figure 67. Current Address Read

(2)-2-2. Random Address Read

The random read operation allows the master to access any memory location at random. Prior to issuing a slave address with the R/W bit = "1", the master must execute a "dummy" write operation first. The master issues a start request, a slave address (R/W bit = "0") and then the register address to read. After the register address is acknowledged, the master immediately reissues the start request and the slave address with the R/W bit = "1". The AK5578 then generates an acknowledge, 1 byte of data and increments the internal address counter by 1. If the master does not generate an acknowledge but generates a stop condition instead, the AK5578 ceases transmission.

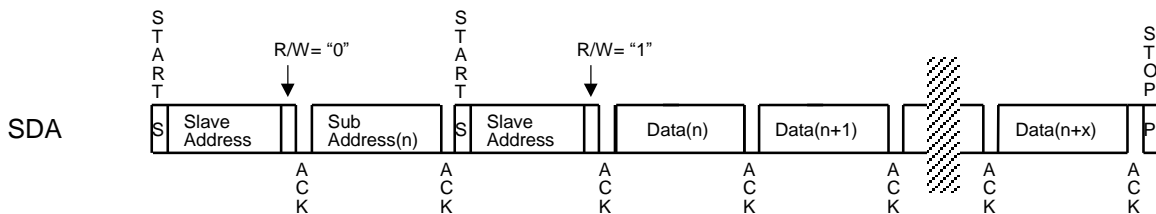

Figure 68. Random Address Read

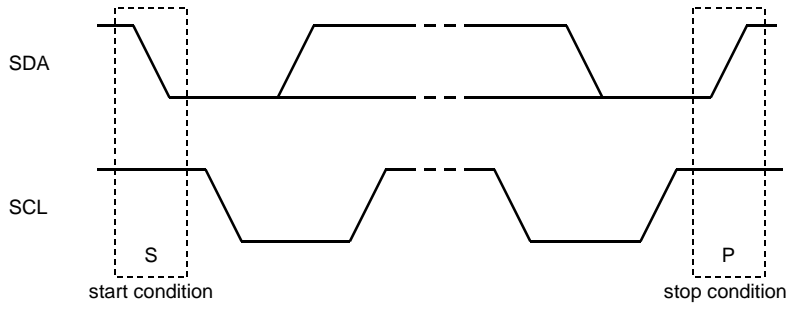

Figure 69. START and STOP Conditions

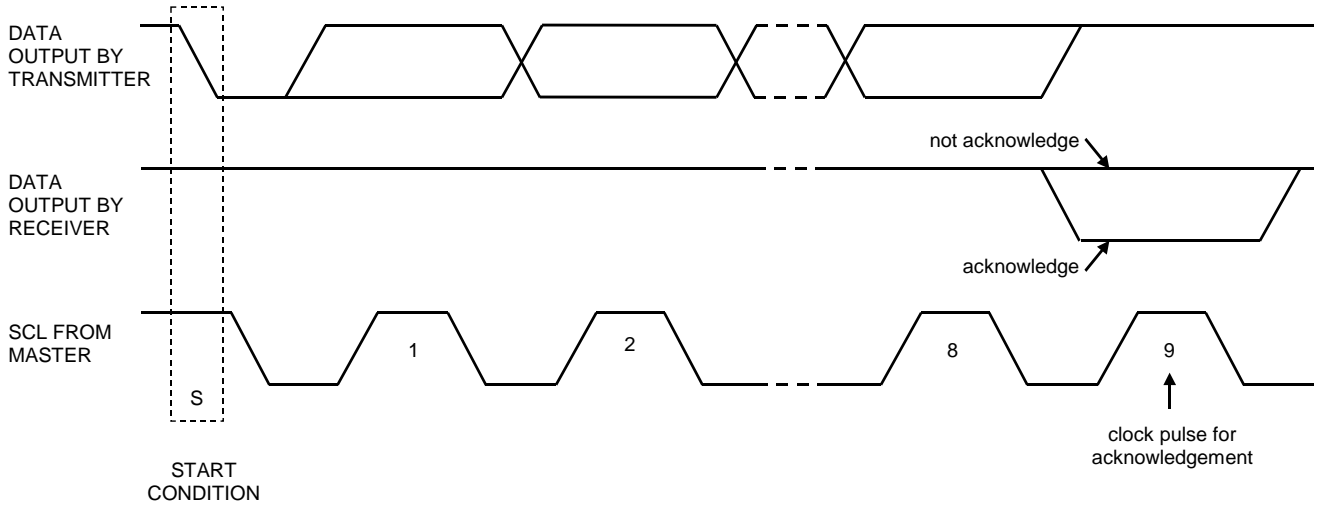

Figure 70. Acknowledge on the I<sup>2</sup>C-Bus

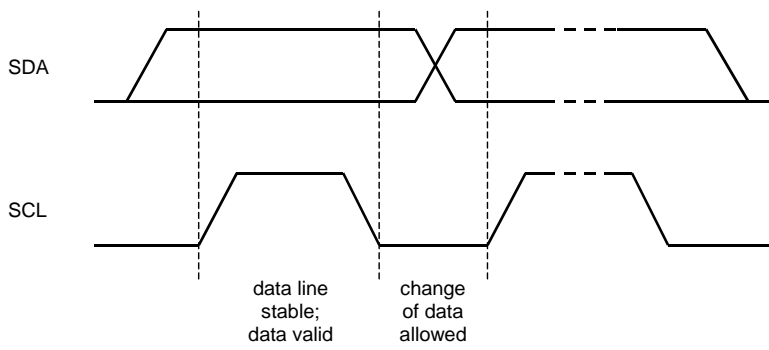

Figure 71. Bit Transfer on the I<sup>2</sup>C-Bus

### ■ Register Map

Addr	Register Name	D7	D6	D5	D4	D3	D2	D1	D0
00H	Power Management1	PW8	PW7	PW6	PW5	PW4	PW3	PW2	PW1
01H	Power Management2	0	0	0	0	0	MONO2	MONO1	RSTN
02H	Control 1	0	CKS3	CKS2	CKS1	CKS0	DIF1	DIF0	HPFE
03H	Control 2	0	TDM1	TDM0	0	0	0	0	0
04H	Control 3	DP	0	0	0	0	0	SD	SLOW
05H	DSD	0	0	DCKS	0	PMOD	DCKB	DSDSEL1	DSDSEL0
06H	TEST1	TST7	TST6	TST5	TST4	TST3	TST2	TST1	TST0
07H	TEST2	0	0	0	0	0	0	0	TRST

Note 24. Data must not be written into addresses from “06H” to “1FH”.

Note 25. The bits indicated as “0” must contain a “0” value. When RSTN bit is set to “0”, the internal digital filter and the control block are reset but the register values are not initialized.

Note 26. When the PDN pin is set to “L”, all registers are initialized to their default values.

### ■ Register Definitions

Addr	Register Name	D7	D6	D5	D4	D3	D2	D1	D0
00H	Power Management1	PW8	PW7	PW6	PW5	PW4	PW3	PW2	PW1
	R/W	R/W	R/W	R/W	R/W	R/W	R/W	R/W	R/W
	Default	1	1	1	1	1	1	1	1

PW8-1: Power Down control for channel 8-1

0: Power OFF

1: Power ON (default)

Addr	Register Name	D7	D6	D5	D4	D3	D2	D1	D0
01H	Power Management2	0	0	0	0	0	MONO2	MONO1	RSTN
	R/W	R/W	R/W	R/W	R/W	R/W	R/W	R/W	R/W
	Default	0	0	0	0	0	0	0	1

RSTN: Internal Timing Reset

0: Reset. All registers are not initialized.

1: Normal Operation (default)

Internal clock timings are reset but registers are not reset.

MONO2-1: Channel Summation mode Select ([Table 17](#), [Table 18](#), [Table 19](#))

00: Not- Summation mode

01: 8-to-2 mode

10: 8-to-4 mode

11: 8-to-1 mode

Addr	Register Name	D7	D6	D5	D4	D3	D2	D1	D0
02H	Control 1	0	CKS3	CKS2	CKS1	CKS0	DIF1	DIF0	HPFE
	R/W	R/W	R/W	R/W	R/W	R/W	R/W	R/W	R/W
	Default	0	0	0	0	0	0	0	1

HPFE: High Pass Filter Enable

0: High Pass Filter OFF

1: High Pass Filter ON (default)

When this bit is "1", digital HPFs for all channels are ON.

DIF1-0: Audio Data Interface Mode Select ([Table 8](#), [Table 9](#))

Select A/D data bit length (24-bit/32-bit) and the format (MSB justified/ I2S Compatible)

CKS3-0: Sampling Speed Mode and MCLK Frequency Select ([Table 5](#))

Select Sampling Speed and MCLK frequency.

Addr	Register Name	D7	D6	D5	D4	D3	D2	D1	D0
03H	Control 2	0	TDM1	TDM0	0	0	0	0	0
	R/W	R/W	R/W	R/W	R/W	R/W	R/W	R/W	R/W
	Default	0	0	0	0	0	0	0	0

TDM1-0: TDM Modes Select ([Table 9](#))

Select the A/D data multiplex mode from Normal, TDM128, TDM256 and TDM512 modes.

Addr	Register Name	D7	D6	D5	D4	D3	D2	D1	D0
04H	Control 3	DP	0	0	0	0	0	SD	SLOW
	R/W	R/W	R/W	R/W	R/W	R/W	R/W	R/W	R/W
	Default	0	0	0	0	0	0	0	0

SLOW: Slow Roll-off Filter Select ([Table 20](#))

0: Sharp Roll-off (default)

1: Slow Roll-off

Select Roll-off characteristic of the digital filter.

SD: Short Delay Select ([Table 20](#))

0: Normal Delay (default)

1: Short Delay

Select group delay of the digital filter.

DP: DSD Mode Select

0: PCM mode (default)

1: DSD mode

Select A/D Data Output Mode.

Addr	Register Name	D7	D6	D5	D4	D3	D2	D1	D0
05H	DSD	0	0	DCKS	0	PMOD	DCKB	DSDSEL 1	DSDSEL 0
	R/W	R/W	R/W	R/W	R/W	R/W	R/W	R/W	R/W
	Default	0	0	0	0	0	0	0	0

DSDSEL1-0: Select the Frequency of DCLK

00: 64fs

01: 128fs (default)

10: 256fs

11: Reserved (128fs)

DCKB: Polarity of DCLK

0: DSD data is output from DCLK Falling Edge (default)

1: DSD data is output from DCLK Rising Edge

PMOD: DSD Phase Modulation Mode

0: Not Phase Modulation Mode (default)

1: Phase Modulation Mode

DSD Output Phase Modulation Mode Enable

DCKS: Master Clock Frequency Select at DSD Mode (DSD Only)

0: 512fs (default)

1: 768fs

Addr	Register Name	D7	D6	D5	D4	D3	D2	D1	D0
06H	TEST1	TST7	TST6	TST5	TST4	TST3	TST2	TST1	TST0
	R/W	RD	RD	RD	RD	RD	RD	RD	RD
	Default	0	0	0	0	0	0	0	0

TST7-0: Test register.

This register must be used as the default setting. Normal operation is not guaranteed if all bits are not "0".

Addr	Register Name	D7	D6	D5	D4	D3	D2	D1	D0
07H	TEST2	0	0	0	0	0	0	0	TRST
	R/W	R/W	R/W	R/W	R/W	R/W	R/W	R/W	W
	Default	0	0	0	0	0	0	0	0

TRST: Test register. This register must be "0".

This register must be "0".

This register must be used as the default setting. Normal operation is not guaranteed if all bits are not "0".



13. Recommended External Circuits

Figure 72 shows recommended external connection.

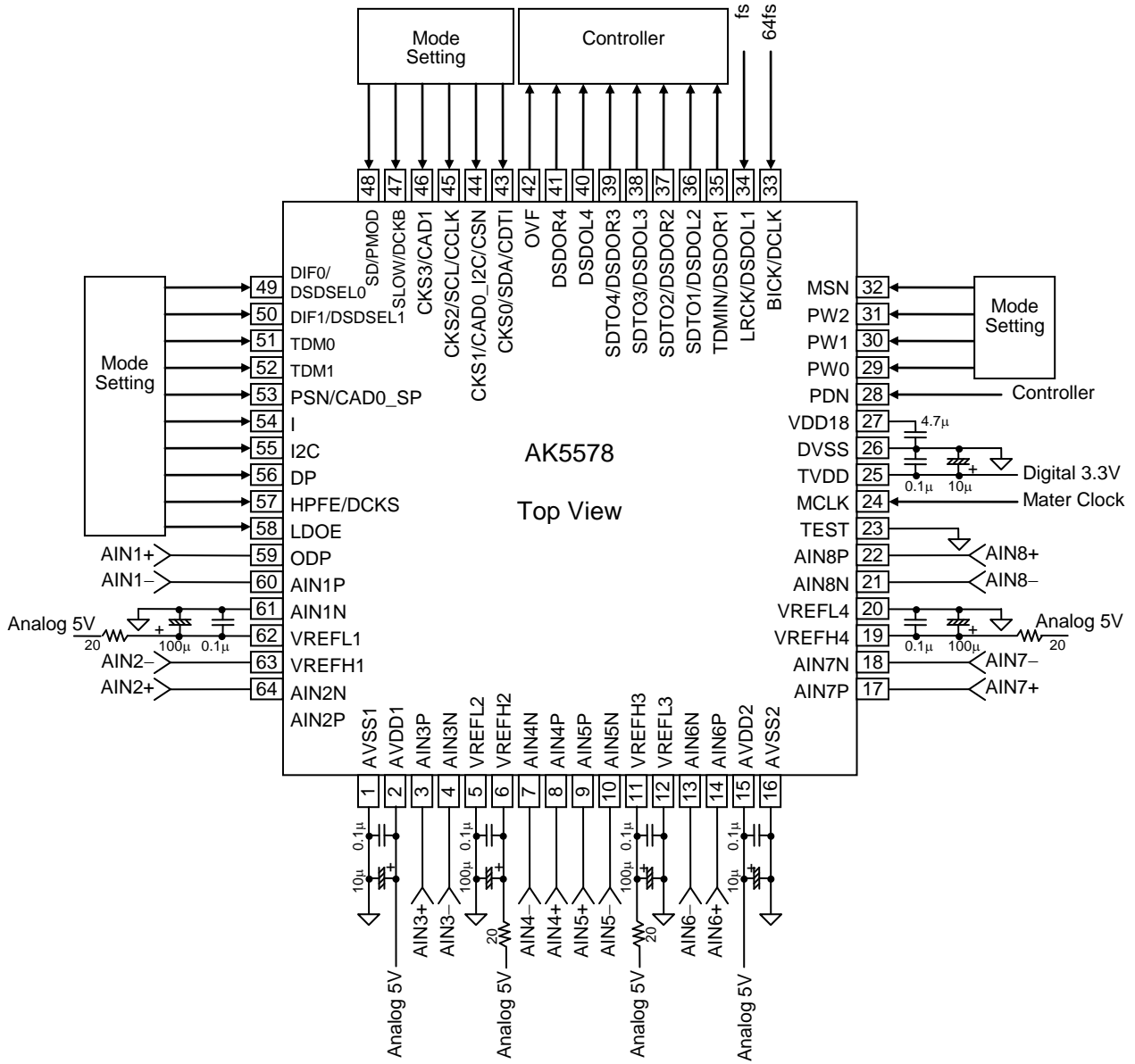

Figure 72. Typical Connection Diagram

Note 27. All digital input pins must not be allowed to float.

### 1. Grounding and Power Supply Decoupling

The AK5578 requires careful attention to power supply and grounding arrangements. Normally AVDD1/2 and TVDD are supplied from analog supply of the system. The power-up sequence between AVDD1/2 and TVDD are not critical when AVDD1/2 and TVDD are supplied separately. **DVSS and AVSS1/2 must be connected to the same analog ground plane.** System analog ground and digital ground should be wired separately and connected together as close as possible to where the supplies are brought onto the printed circuit board. Decoupling capacitors for high frequency should be placed as near as possible to the supply pin.

### 2. Reference Voltage

The differential voltage between the VREFH1-4 pins and the VREFL1-4 pins are the common voltage of A/D conversion. The VREFL1-4 pins are normally connected to AVSS. In order to remove a high frequency noise, connect a 20  $\Omega$  resistor between the VREFH1-4 pins and analog 5 V supply, and connect a 0.1  $\mu\text{F}$  ceramic capacitor in parallel with an 100  $\mu\text{F}$  electrolytic capacitor between the VREFH1-4 pins and the VREFL1-4 pins. Especially the ceramic capacitor should be connected as close as possible to the pin. All digital signals, especially clocks, should be kept away from the VREFH1-4 pins and VREFL1-4 pins in order to avoid unwanted noise coupling into the AK5578.

### 3. Analog Inputs

The Analog input signal is differentially supplied into the modulator via the AINn+ and the AINn- pins (n= 1-8). The input voltage is the difference between the ALINn+ and ALINn- pins (n= 1-8). The full scale signal on each pin is nominally  $\pm 2.8$  V (typ). A voltage from AVSS1/2 to AVDD1/2 can be input to the AK5578. The output code format is two's complement. The internal HPF removes DC offset (including DC offset by the ADC itself).

The AK5578 requires a +5 V analog supply voltage. Any voltage which exceeds the upper limit of AVDD1/2+0.3 V and lower limit of AVSS1/2-0.3 V and any current beyond 10 mA for the analog input pins should be avoided. Excessive currents to the input pins may damage the device. Hence input pins must be protected from signals at or beyond these limits. Use caution especially when using  $\pm 15$  V for other analog circuits in the system.

4. External Analog Circuit Examples

Figure 73 shows an input buffer circuit example 1. (1<sup>st</sup> order HPF;  $f_c = 0.70$  Hz, 2<sup>nd</sup> order LPF;  $f_c = 351$  kHz, gain =  $-14.5$  dB). The analog signal is able to input through XLR or BNC connectors. (short JP1 and JP2 for BNC input, open JP1 and JP2 for XLR input). The input level of this circuit is 14.9 Vpp (AK5578: 2.8 Vpp Typ.). When using this circuit, analog characteristics at  $f_s = 48$  kHz is DR = 121 dB, S/(N+D) = 112 dB. The S/(N+D) characteristics of the AK5578 varies depending on DC bias current of the input signal. Set the DC bias voltage in a range from  $0.49 \times AVDD$  to  $0.51 \times AVDD$  for a better characteristic.

\* Film capacitors are recommended for the components shown as 15nF and 1 nF in the figure below.

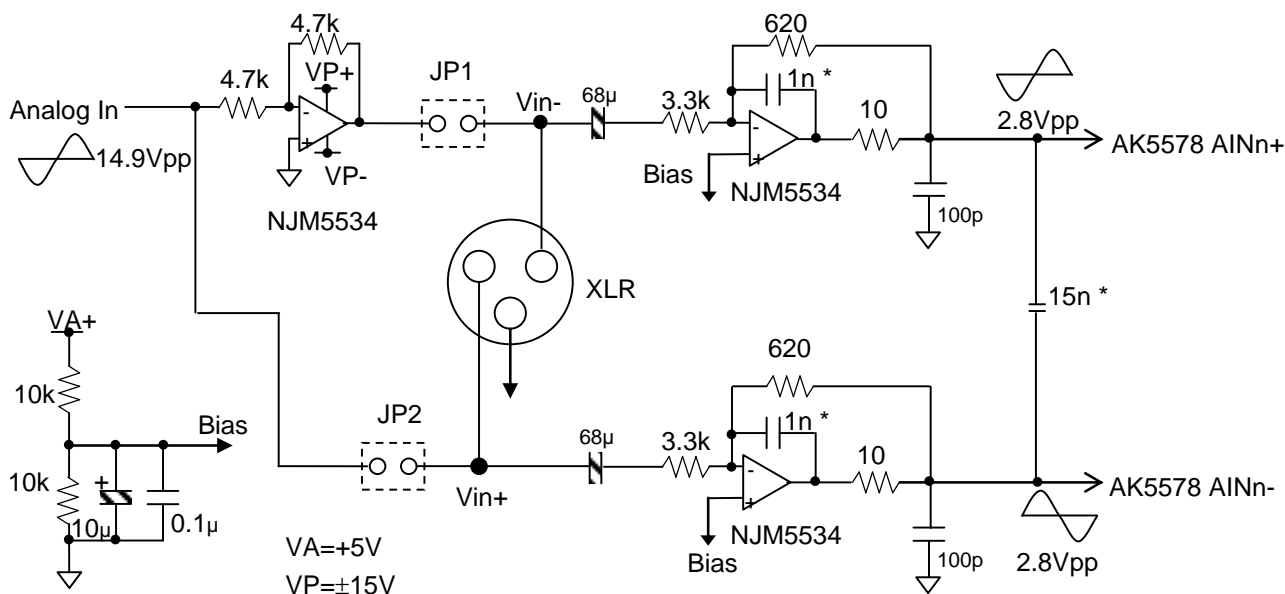

Figure 73. Input Buffer Example1

$f_{in}$	1Hz	10Hz
Frequency Response	-1.77dB	-0.02dB

Table 23. Frequency Response of HPF

$f_{in}$	20kHz	40kHz	80kHz	6.144MHz
Frequency Response	0.00dB	0.00dB	0.00dB	-49.68dB

Table 24. Frequency Response of LPF

14. Package

■ Outline Dimensions

64-pin QFN (Unit mm)

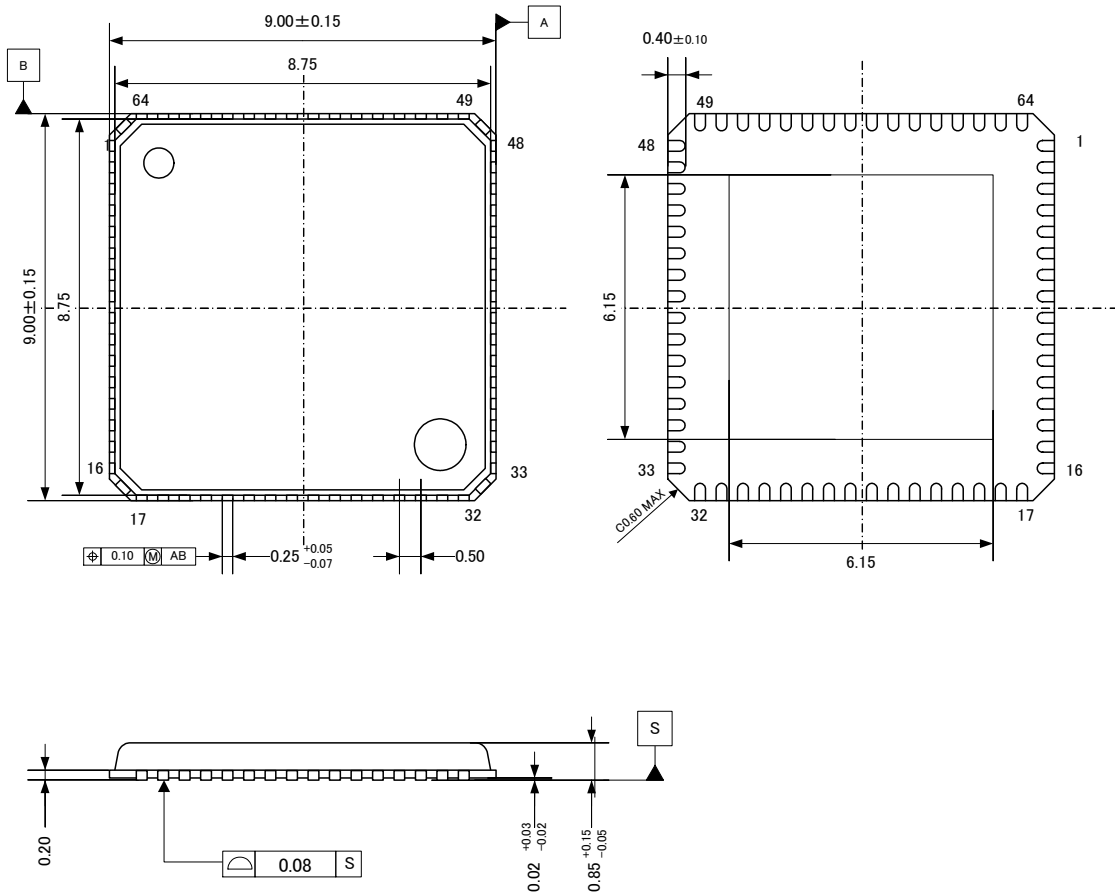

■ Material & Lead Finish

Package molding compound: Epoxy resin

Lead frame material: Cu

Terminal surface treatment: Solder (Pb free) plate

■ Marking



- 1) Pin #1 indication
- 2) AKM Logo
- 3) Date Code : XXXXXXX (7 digits)
- 4) Marketing Code : AK5578EN
- 5) Audio 4 pro Logo

**15. Ordering Guide**

AK5578EN            -40 - 105 °C            64-pin QFN  
AKD5578            Evaluation Board for AK5578

**16. Revision History**

Date (Y/M/D)	Revision	Reason	Page	Contents
15/12/18	00	First Edition		

**IMPORTANT NOTICE**

0. Asahi Kasei Microdevices Corporation ("AKM") reserves the right to make changes to the information contained in this document without notice. When you consider any use or application of AKM product stipulated in this document ("Product"), please make inquiries the sales office of AKM or authorized distributors as to current status of the Products.
1. All information included in this document are provided only to illustrate the operation and application examples of AKM Products. AKM neither makes warranties or representations with respect to the accuracy or completeness of the information contained in this document nor grants any license to any intellectual property rights or any other rights of AKM or any third party with respect to the information in this document. You are fully responsible for use of such information contained in this document in your product design or applications. AKM ASSUMES NO LIABILITY FOR ANY LOSSES INCURRED BY YOU OR THIRD PARTIES ARISING FROM THE USE OF SUCH INFORMATION IN YOUR PRODUCT DESIGN OR APPLICATIONS.
2. The Product is neither intended nor warranted for use in equipment or systems that require extraordinarily high levels of quality and/or reliability and/or a malfunction or failure of which may cause loss of human life, bodily injury, serious property damage or serious public impact, including but not limited to, equipment used in nuclear facilities, equipment used in the aerospace industry, medical equipment, equipment used for automobiles, trains, ships and other transportation, traffic signaling equipment, equipment used to control combustions or explosions, safety devices, elevators and escalators, devices related to electric power, and equipment used in finance-related fields. Do not use Product for the above use unless specifically agreed by AKM in writing.
3. Though AKM works continually to improve the Product's quality and reliability, you are responsible for complying with safety standards and for providing adequate designs and safeguards for your hardware, software and systems which minimize risk and avoid situations in which a malfunction or failure of the Product could cause loss of human life, bodily injury or damage to property, including data loss or corruption.
4. Do not use or otherwise make available the Product or related technology or any information contained in this document for any military purposes, including without limitation, for the design, development, use, stockpiling or manufacturing of nuclear, chemical, or biological weapons or missile technology products (mass destruction weapons). When exporting the Products or related technology or any information contained in this document, you should comply with the applicable export control laws and regulations and follow the procedures required by such laws and regulations. The Products and related technology may not be used for or incorporated into any products or systems whose manufacture, use, or sale is prohibited under any applicable domestic or foreign laws or regulations.
5. Please contact AKM sales representative for details as to environmental matters such as the RoHS compatibility of the Product. Please use the Product in compliance with all applicable laws and regulations that regulate the inclusion or use of controlled substances, including without limitation, the EU RoHS Directive. AKM assumes no liability for damages or losses occurring as a result of noncompliance with applicable laws and regulations.
6. Resale of the Product with provisions different from the statement and/or technical features set forth in this document shall immediately void any warranty granted by AKM for the Product and shall not create or extend in any manner whatsoever, any liability of AKM.
7. This document may not be reproduced or duplicated, in any form, in whole or in part, without prior written consent of AKM.