



Grayhill, Inc.

62S11-H9-050S

Dalis numeris: 62S11-H9-050S

Gamintojas / Gamintojas: Grayhill, Inc.

Prekės aprašymas: ROTARY ENCODER OPTICAL 32PPR

Duomenų lapai:  62S11-H9-050S.pdfRoHS statusas:  Švinas nemokamas / RoHS atitinka

Laivas iš: Honkongas

Siuntimo būdas: DHL/Fedex/TNT/UPS/EMS

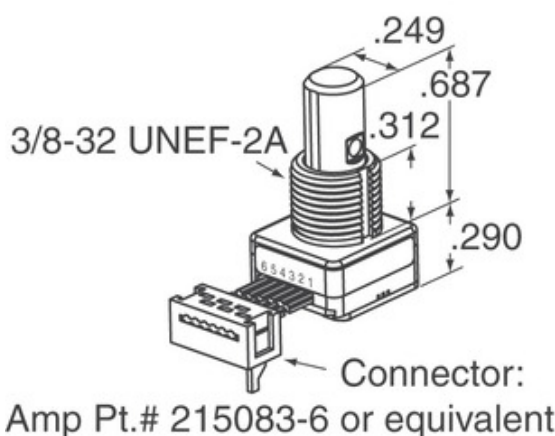

Vaizdas gali būti atvaizdavimas. Žr. Produkto detalių specifikacijas.

[PRAŠYMAS KOTIRUOTI](#)

62S11-H9-050S specifikacijos

DALIES NUMERIS	62S11-H9-050S
GAMINTOJAS	Grayhill, Inc.
APIBŪDINIMAS	ROTARY ENCODER OPTICAL 32PPR
"LEAD FREE STATUS / ROHS" STATUSAS	Švinas nemokamas / RoHS atitinka
DUOMENŲ LAPAS	 62S11-H9-050S.pdf
ĮTAMPA - TIEKIMAS	5V
NUTRAUKIMO STILIUS	Cable Leads
SERIJA	62S
ROTATIONAL LIFE (CYCLES MIN)	1M
IMPULSAI PER REVOLIUCIJĄ	32
IŠVESTIES TIPAS	Quadrature (Incremental)
KITI VARDAI	62S11H9050S
ORIENTACIJA	Vertical
MONTAVIMO TIPAS	Panel Mount
DRĖGMĖS JAUTRUMO LYGIS (MSL)	1 (Unlimited)
GAMINTOJO STANDARTINIS PRATĖSIMO LAIKAS	8 Weeks
"LEAD FREE STATUS / ROHS" STATUSAS	Lead free / RoHS Compliant
KODAVIMO TIPAS	Optical
DETENT	Yes
PASTATYTAS JUNGIKLIS	Yes
PAVAROS TIPAS	1/4" Dia Flatted End

Susijusios žymės

Grayhill, Inc. 62S11-H9-050S	62S11-H9-050S platintojas	62S11-H9-050S tiekėjas
62S11-H9-050S kaina	62S11-H9-050S nuotraukos	62S11-H9-050S vaizdas
62S11-H9-050S PDF duomenų lapas	62S11-H9-050S atsisiųsti duomenų lentelę	62S11-H9-050S duomenų lapas
62S11-H9-050S atsargos	Pirkite 62S11-H9-050S	Pirkite Grayhill, Inc. 62S11-H9-050S
Grayhill, Inc. 62S11-H9-050S	Grayhill, Inc. tiekėjas	Grayhill, Inc. platintojas
Grayhill, Inc. 62S11-H9-050S	Grayhill Inc. 62S11-H9-050S	

Susiję produktai

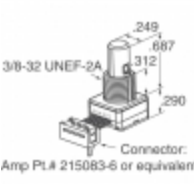
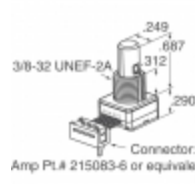
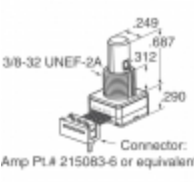
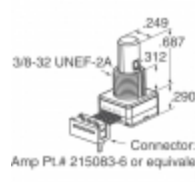
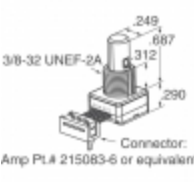
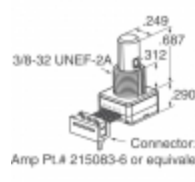
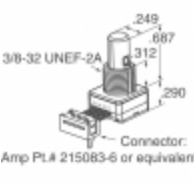
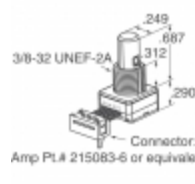
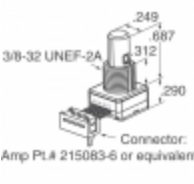
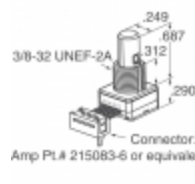
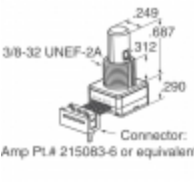
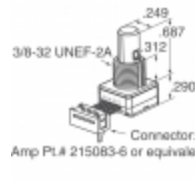
 <p>62S11-H9-040C Gamintojai: Grayhill, Inc. apibūdinimas: ROTARY ENCODER OPTICAL 32PPR Sandelyje: Out stock</p> <p>RFQ</p>	 <p>62S11-H9-040S Gamintojai: Grayhill, Inc. apibūdinimas: ROTARY ENCODER OPTICAL 32PPR Sandelyje: Out stock</p> <p>RFQ</p>
 <p>62S11-L0-020C Gamintojai: Grayhill, Inc. apibūdinimas: ROTARY ENCODER OPTICAL 32PPR Sandelyje: Out stock</p> <p>RFQ</p>	 <p>62S11-H9-020C Gamintojai: Grayhill, Inc. apibūdinimas: ROTARY ENCODER OPTICAL 32PPR Sandelyje: Out stock</p> <p>RFQ</p>
 <p>62S11-H9-PH Gamintojai: Grayhill, Inc. apibūdinimas: ROTARY ENCODER OPTICAL 32PPR Sandelyje: Out stock</p> <p>RFQ</p>	 <p>62S11-L0-020CH Gamintojai: Grayhill, Inc. apibūdinimas: ROTARY ENCODER OPTICAL 32PPR Sandelyje: Out stock</p> <p>RFQ</p>
 <p>62S11-H9-P Gamintojai: Grayhill, Inc. apibūdinimas: ROTARY ENCODER OPTICAL 32PPR Sandelyje: Out stock</p> <p>RFQ</p>	 <p>62S11-H0-PH Gamintojai: Grayhill, Inc. apibūdinimas: ROTARY ENCODER OPTICAL 32PPR Sandelyje: Out stock</p> <p>RFQ</p>
 <p>62S11-H9-060C Gamintojai: Grayhill, Inc. apibūdinimas: ROTARY ENCODER OPTICAL 32PPR Sandelyje: Out stock</p> <p>RFQ</p>	 <p>62S11-H9-020S Gamintojai: Grayhill, Inc. apibūdinimas: ROTARY ENCODER OPTICAL 32PPR Sandelyje: Out stock</p> <p>RFQ</p>
 <p>62S11-H9-060SH Gamintojai: Grayhill, Inc. apibūdinimas: ROTARY ENCODER OPTICAL 32PPR Sandelyje: Out stock</p> <p>RFQ</p>	 <p>62S11-H9-025S Gamintojai: Grayhill, Inc. apibūdinimas: ROTARY ENCODER OPTICAL 32PPR Sandelyje: Out stock</p> <p>RFQ</p>

Autorinės teisės © 2020 - patikimas elektroninių komponentų platintojas - Ocean-Components.com

El. Paštas: Info@Ocean-Components.com

Adresas: Room 2102, Connaught Commercial Building, 185 Wan Chai Rd, Wan Chai, Hong Kong

