

High Voltage LED Series  
Chip on Board

# LCo80D – Gen.2



High efficacy COB LED package  
well-suited for use in spotlight applications

## Features & Benefits

- Chip on Board (COB) solution makes it easy to design in
- Simple assembly reduces manufacturing cost
- Low thermal resistance
- InGaN/GaN MQW LED with long time reliability

## Applications

- Spotlight / Downlight
- LED Retrofit Bulbs
- Outdoor Illumination



## Table of Contents

1.	Characteristics	-----	3
2.	Product Code Information	-----	5
3.	Typical Characteristics Graphs	-----	8
4.	Outline Drawing & Dimension	-----	10
5.	Reliability Test Items & Conditions	-----	11
6.	Label Structure	-----	12
7.	Packing structure	-----	13
8.	Precautions in Handling & Use	-----	14

## 1. Characteristics

### a) Absolute Maximum Rating

Item	Symbol	Rating	Unit	Condition
Ambient / Operating Temperature	$T_a$	-40 ~ +105	°C	-
Storage Temperature	$T_{stg}$	-40 ~ +120	°C	-
LED Junction Temperature	$T_J$	150	°C	-
Case Temperature	$T_c$	115	°C	-
Forward Current	$I_F$	4140	mA	-
Power Dissipation	$P_D$	232.6	W	-
ESD (HBM)	-	±2	kV	-
ESD (MM)	-	±0.5	kV	-

### b) Electro-optical Characteristics ( $I_F = 1620$ mA, $T_A = 85$ °C)

Item	Unit	Rank	Min.	Typ.	Max.
Forward Voltage ( $V_F$ )	V	1Z	47.8	52	56.2
Color Rendering Index ( $R_a$ )	-	3	70	-	-
		5	80	-	-
		7	90	-	-
Thermal Resistance (junction to case point)	°C/W		-	0.16	-
Beam Angle	°		-	115	-
Working Voltage for Insulation	V				50
Nominal Power	W			84.2	

### c) Photo-biological Safety

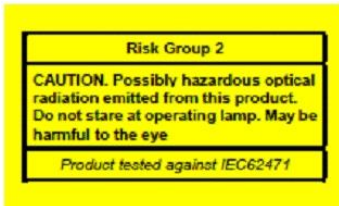
Item	Contents
Photo-biological Safety	<p>Risk Group2, Ethr(lux) - 679, Distance to reach RG1(m) - 2.88            In the If=sorting current, This product is Risk Group1. by certificate of Samsung Electronics</p> 

#### Notes:

- 1) The COB is tested in pulsed condition at rated test current (10 ms pulse width) and rated temperature ( $T_J = T_C = T_A = 85$  °C)
- 2) Samsung maintains measurement tolerance of: forward voltage = ±5 %, CRI = ±1
- 3) Refer to the derating curve, '3. Typical Characteristics Graph' designed within the range.

### c) Luminous Flux Characteristics ( $I_F = 1620 \text{ mA}$ )

CRI (Ra) Min.	Nominal CCT (K)	Flux Rank	Flux @ $T_c = 85 \text{ }^\circ\text{C}$ (lm)		
			Min.	Typ.	Max.
70	3000	D2	12792	13465	-
	4000	D2	13202	13896	-
	5000	D2	13406	14112	-
80	2700	D2	11224	11815	-
	3000	D2	11845	12468	-
	3500	D2	12209	12852	-
	4000	D2	12466	13123	-
	5000	D2	12536	13196	-
	5700	D2	12596	13258	-
90	6500	D2	12465	13121	-
	2700	D2	9649	10157	
	3000	D2	10195	10731	
	3500	D2	10454	11004	
	4000	D2	10685	11247	
	5000	D2	10806	11375	
	5700	D2	10806	11375	

#### Notes:

- 1) The COB is tested in pulsed operating condition at rated test current (10 ms pulse width) and rated temperature ( $T_J = T_C = 85 \text{ }^\circ\text{C}$ ).
- 2) Samsung maintains measurement tolerance of: Luminous flux =  $\pm 7 \%$ , CRI =  $\pm 1$

## 2. Product Code Information

1	2	3	4	5	6	7	8	9	10	11	12	13	14	15	16	17	18
S	P	H	W	H	A	H	D	N	M	2	5	1	Z	W	3	D	2

Digit	PKG Information	Code	Specification
1 2 3	Samsung Package High Power	<b>SPH</b>	
4 5	Color	<b>WH</b>	White
6	Product Version	<b>A</b>	
7 8	Form Factor	<b>HD</b>	COB
9	Lens Type	<b>N</b>	No lens
10	Wattage or Model	<b>M</b>	LC080D
11	Internal Code	<b>2</b>	
12	CRI & Sorting Temperature	<b>3</b> <b>5</b> <b>7</b>	Min. 70 (85°C) Min. 80 (85°C) Min. 90 (85°C)
13 14	Forward Voltage (V)	<b>1Z</b>	47.8~56.2
15	CCT (K)	<b>W</b> <b>V</b> <b>U</b> <b>T</b> <b>R</b> <b>Q</b> <b>P</b>	2700K 3000K 3500K 4000K 5000K 5700K 6500K
16	MacAdam Step	<b>2</b> <b>3</b>	MacAdam 2-step MacAdam 3-step
17 18	Luminous Flux (Lm)	<b>D2</b>	COB D-series Gen.2 level

a) Binning Structure ( $I_F = 1620 \text{ mA}$ ,  $T_C = 85 \text{ }^\circ\text{C}$ )

CRI ( $R_a$ ) Min.	Nominal CCT (K)	Product Code	$V_f$ Rank	Chrom. Bin	Flux Rank	Flux Range ( $\Phi_v$ , lm)
70	3000	SPHWHAHDNM231ZV3D2	1Z	V3	D2	12792 ~
	4000	SPHWHAHDNM231ZT3D2	1Z	T3	D2	13202 ~
	5000	SPHWHAHDNM231ZR3D2	1Z	R3	D2	13406 ~
80	2700	SPHWHAHDNM251ZW3D2	1Z	W3	D2	11224 ~
		SPHWHAHDNM251ZW2D2		W2		
	3000	SPHWHAHDNM251ZV3D2	1Z	V3	D2	11845 ~
		SPHWHAHDNM251ZV2D2		V2		
	3500	SPHWHAHDNM251ZU3D2	1Z	U3	D2	12209 ~
		SPHWHAHDNM251ZU2D2		U2		
	4000	SPHWHAHDNM251ZT3D2	1Z	T3	D2	12466 ~
		SPHWHAHDNM251ZT2D2		T2		
	5000	SPHWHAHDNM251ZR3D2	1Z	R3	D2	12536 ~
	5700	SPHWHAHDNM251ZQ3D2	1Z	Q3	D2	12596 ~
	6500	SPHWHAHDNM251ZP3D2	1Z	P3	D2	12465 ~
	90	2700	SPHWHAHDNM271ZW3D2	1Z	W3	D2
SPHWHAHDNM271ZW2D2			W2			
3000		SPHWHAHDNM271ZV3D2	1Z	V3	D2	10195 ~
		SPHWHAHDNM271ZV2D2		V2		
3500		SPHWHAHDNM271ZU3D2	1Z	U3	D2	10454 ~
		SPHWHAHDNM271ZU2D2		U2		
4000		SPHWHAHDNM271ZT3D2	1Z	T3	D2	10685 ~
		SPHWHAHDNM271ZT2D2		T2		
5000		SPHWHAHDNM271ZR3D2	1Z	R3	D2	10806 ~
5700		SPHWHAHDNM271ZQ3D2	1Z	Q3	D2	10806 ~

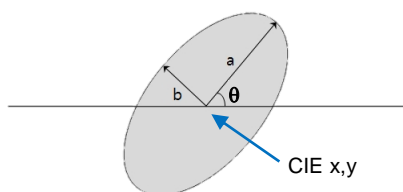
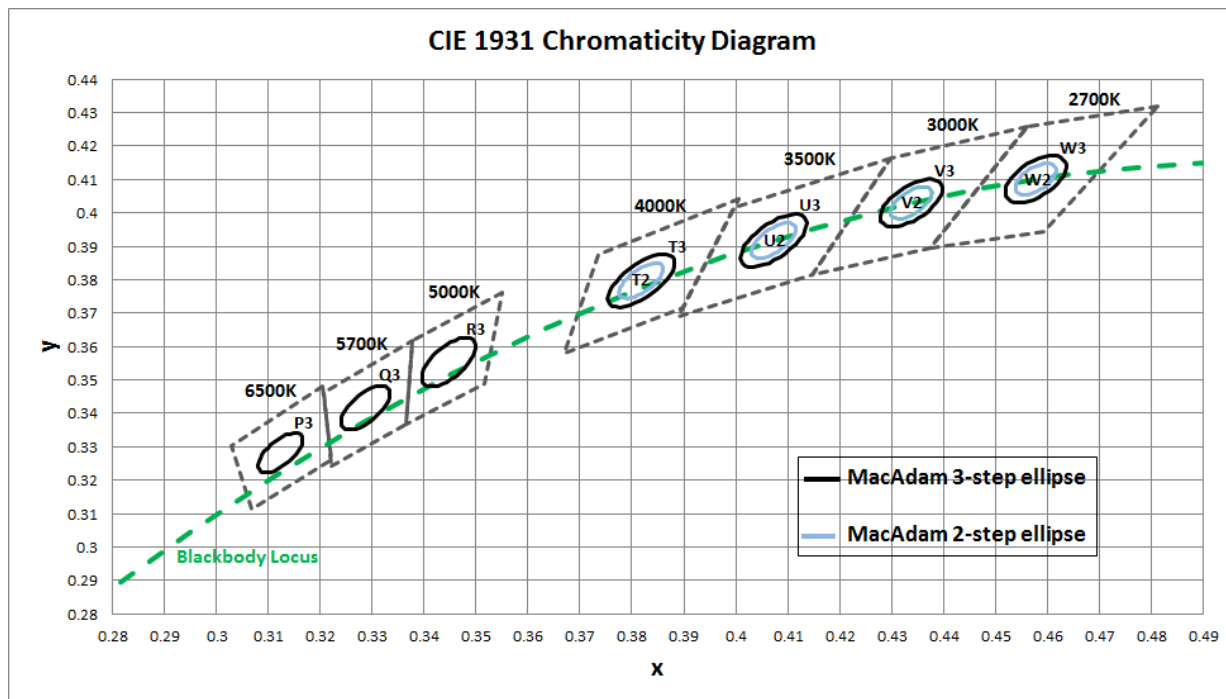
b) Chromaticity Region & Coordinates ( $I_F = 1620 \text{ mA}$ ,  $T_J = 85 \text{ }^\circ\text{C}$ )

MacAdam Ellipse (W2, W3)					
Step	CIE x	CIE y	$\theta$	a	b
2-step	0.4578	0.4101	53.70	0.0054	0.0028
3-step	0.4578	0.4101	53.70	0.0081	0.0042

MacAdam Ellipse (V2, V3)					
Step	CIE x	CIE y	$\theta$	a	b
2-step	0.4338	0.403	53.22	0.0056	0.0027
3-step	0.4338	0.4030	53.22	0.0083	0.0041

MacAdam Ellipse (U2, U3)					
Step	CIE x	CIE y	$\theta$	a	b
2-step	0.4073	0.3917	54.00	0.0062	0.0028
3-step	0.4073	0.3917	54.00	0.0093	0.0041

MacAdam Ellipse (T2, T3)					
Step	CIE x	CIE y	$\theta$	a	b
2-step	0.3818	0.3797	53.72	0.0063	0.0027
3-step	0.3818	0.3797	53.72	0.0094	0.0040

MacAdam Ellipse (R3)					
Step	CIE x	CIE y	$\theta$	a	b
3-step	0.3447	0.3553	59.62	0.0082	0.0035

MacAdam Ellipse (Q3)					
Step	CIE x	CIE y	$\theta$	a	b
3-step	0.3287	0.3417	59.0950	0.0075	0.0032

MacAdam Ellipse (P3)					
Step	CIE x	CIE y	$\theta$	a	b
3-step	0.3123	0.3282	58.5700	0.0067	0.0029

**Note:**

Samsung maintains measurement tolerance of:  $C_x, C_y = \pm 0.005$

### 3. Typical Characteristics Graphs

a) Spectrum Distribution ( $I_f = 1620 \text{ mA}$ ,  $T_J = 85 \text{ }^\circ\text{C}$ )

CRI Ra 70+

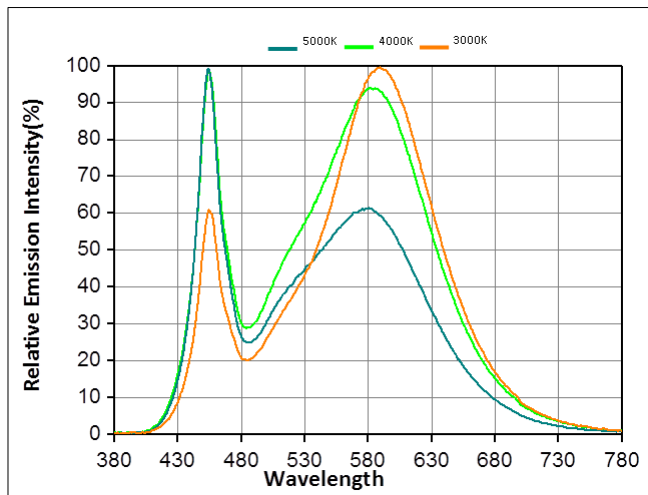

CRI Ra 80+

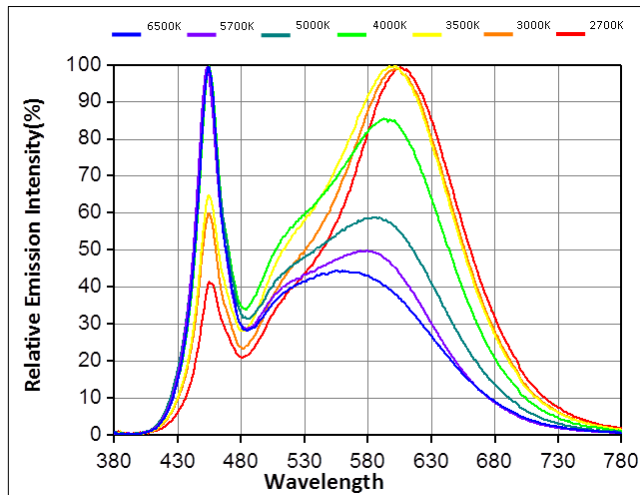

CRI Ra 90+

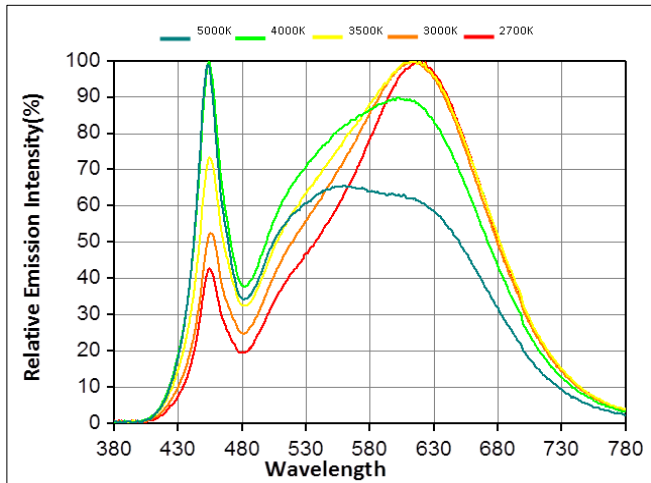

b) Forward Current Characteristics ( $T_J = 85 \text{ }^\circ\text{C}$ )

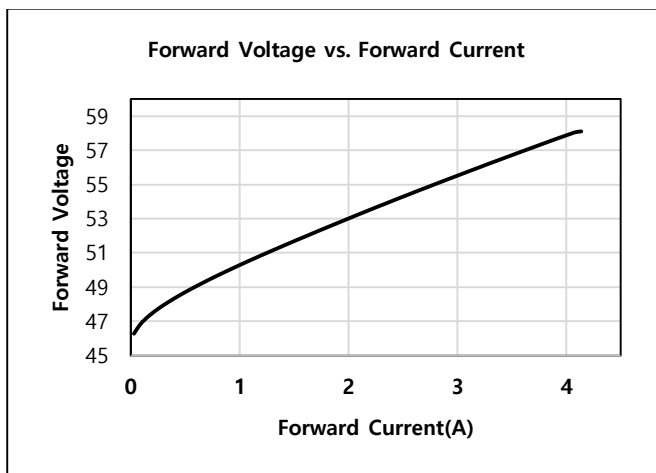
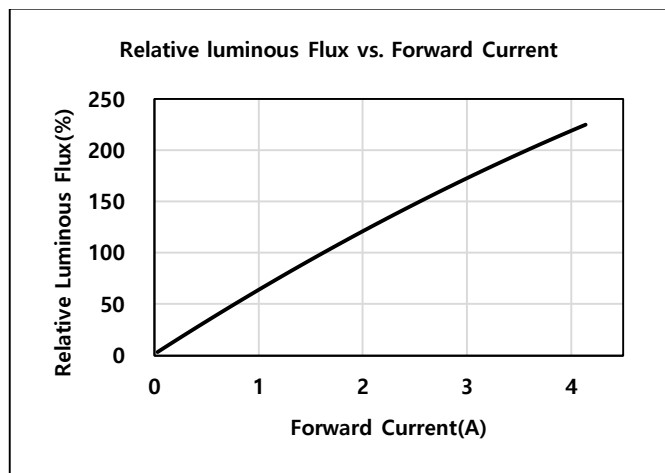



c) Temperature Characteristics ( $I_f = 1620\text{mA}$ )

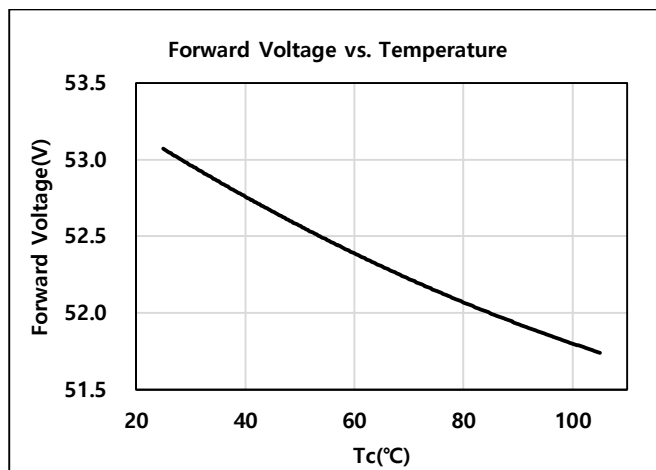
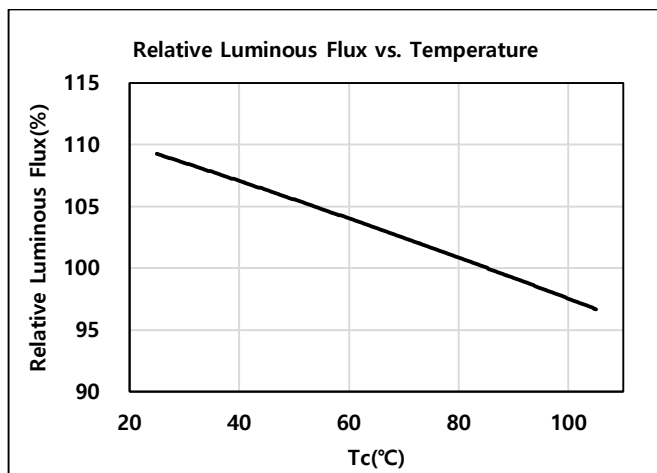

d) Color Shift Characteristics ( $T_j = 85\text{ }^\circ\text{C}$ ,  $I_f = 1620\text{mA}$ , CRI = 80+)

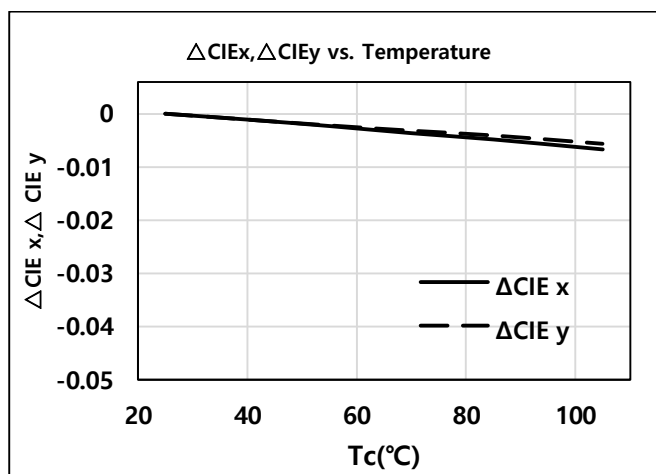
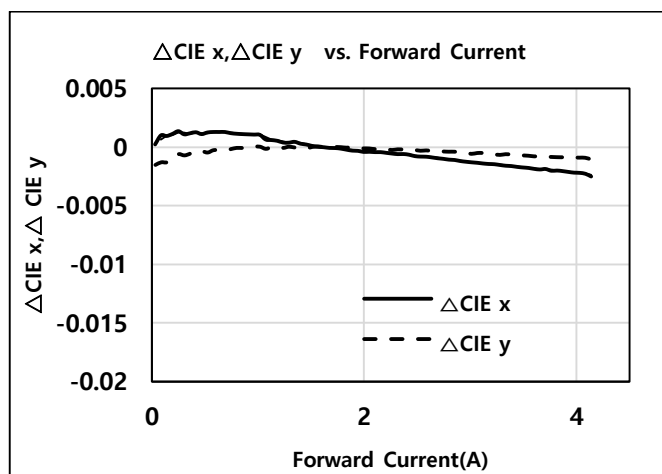

e) Beam Angle Characteristics ( $I_f = 1620\text{ mA}$ ,  $T_j = 85\text{ }^\circ\text{C}$ )

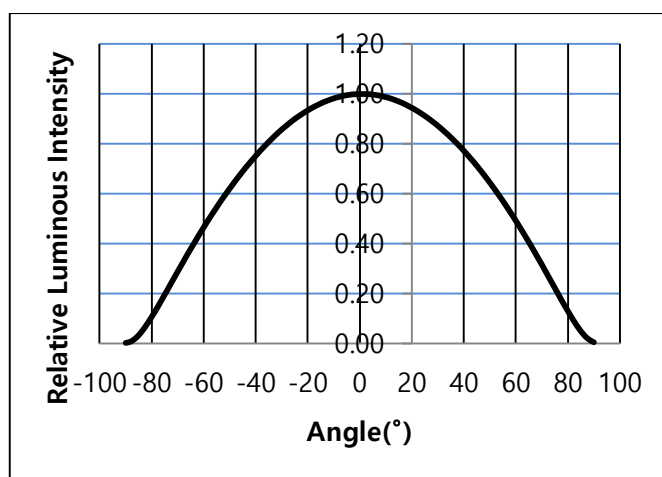

f) Derating Characteristics

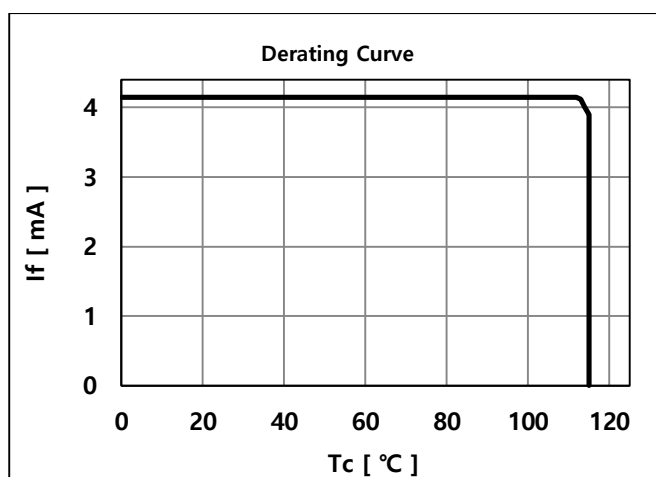

#### 4. Outline Drawing & Dimension

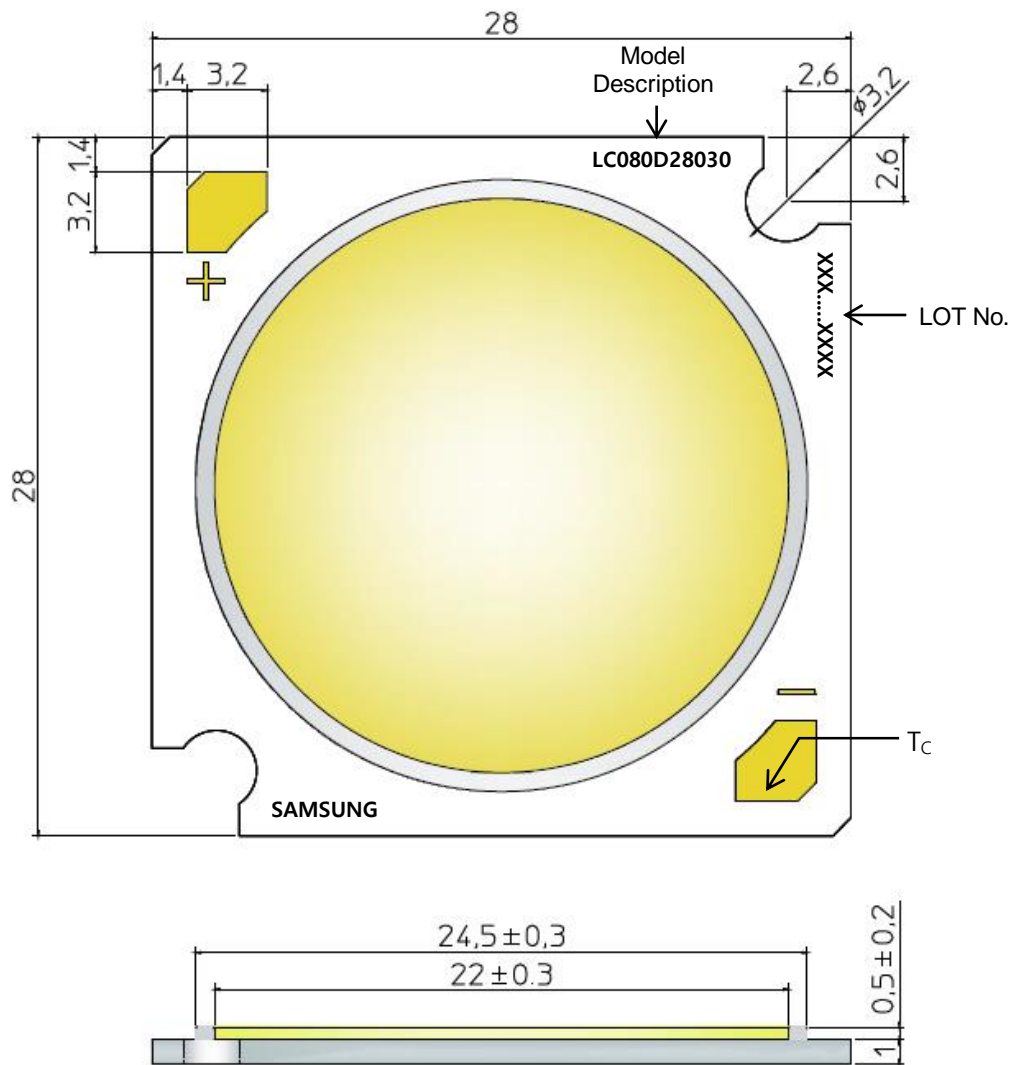

1. Unit: mm
2. Tolerance:  $\pm 0.3$  mm

Item	Dimension	Tolerance	Unit
Length	28.0	$\pm 0.15$	mm
Width	28.0	$\pm 0.15$	mm
Height	1.50	$\pm 0.20$	mm
Light Emitting Surface (LES) Diameter	22.0	$\pm 0.30$	mm

Note: Denoted product information above is only an example  
( LC080D28030 : LC080D, CRI80+, 3000K )

## 5. Reliability Test Items & Conditions

### a) Test Items

Test Item	Test Condition	Test Hour / Cycle
High Temperature Humidity Life Test	60 °C, 90 % RH,, DC Derating, I <sub>F</sub>	1000 h
High Temperature Life Test	85 °C, DC Derating, I <sub>F</sub>	1000 h
Low Temperature Life Test	-40 °C, DC, Derating I <sub>F</sub>	1000 h
High Temperature Storage	120 °C	1000 h
Low Temperature Storage	-40 °C	1000 h
Temperature Humidity Storage	60 °C, 90% RH	1000h
Temperature Cycle On/Off Test	-40 °C / 85 °C each 20 min, 30 min transfer power on/off each 5 min, DC Derating, I <sub>F</sub> = max	100 cycles
ESD (HBM)	R <sub>1</sub> : 10 MΩ R <sub>2</sub> : 1.5 kΩ C: 100 pF	5 times
ESD (MM)	R <sub>1</sub> : 10 MΩ R <sub>2</sub> : 0 kΩ C: 200 pF	5 times
Vibration Test	20 ~ 80 Hz (displacement: 0.06 inch, max. 20 g) 80 ~ 2 kHz (max. 20 g) min. frequency ↔ max. frequency 4 min transfer	4 times
Mechanical Shock Test	1500g, 0.5 ms each of the 6 surfaces (3 axis x 2 sides)	5 times
Sulfur Resistance	25 °C, 75%, H2S 15 ppm	504h

### b) Criteria for Judging the Damage

Item	Symbol	Test Condition (T <sub>c</sub> = 25 °C)	Limit	
			Min.	Max.
Forward Voltage	V <sub>F</sub>	I <sub>F</sub> = 1620 mA	L.S.L. * 0.9	U.S.L. * 1.1
Luminous Flux	Φ <sub>v</sub>	I <sub>F</sub> = 1620 mA	L.S.L. * 0.7	U.S.L. * 1.3

## 6. Label Structure

### a) Label Structure

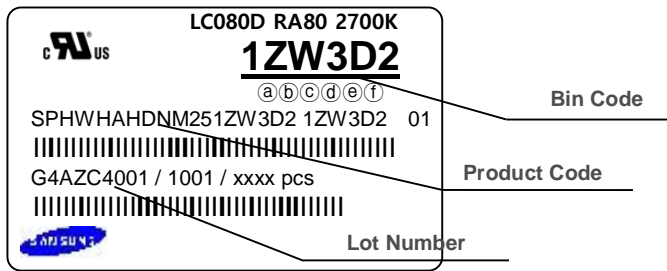

Note: Denoted bin code and product code above is only an example (see description on page 5)

Bin Code:

- ⒶⒷ: Forward Voltage bin (refer to page 11)
- ⒸⒹ: Chromaticity bin (refer to page 9-10)
- ⒺⒻ: Luminous Flux bin (refer to page 6)

### b) Lot Number

The lot number is composed of the following characters:

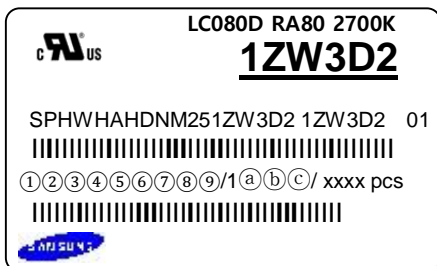

① ③④⑤⑥⑦⑧⑨ / 1ⒶⒷⒸ / xxxx pcs

- ① : Production site (S: Giheung, Korea, G: Tianjin, China)
- ② : 4 (LED)
- ③ : Product state (A: Normal, B: Bulk, C: First Production, R: Reproduction, S: Sample)
- ④ : Year (Z: 2015, A: 2016, B: 2017...)
- ⑤ : Month (1~9, A, B, C)
- ⑥⑦⑧⑨ : Day (1~9, A, B~V)
- ⒶⒷⒸ : Product serial number (001 ~ 999)

## 7. Packing Structure

Packing material	Max. quantity in pcs of COB	Dimension(mm)			
		Length	Width	Height	Tolerance
Tray	16	200	200	8	1
Anti-Static Bag	80 (5 trays)	320	270	-	+/- 0.5
Outer Box (Small)	160 (2 bags)	225	225	65	5
Outer Box (Middle)	320 (4 bags)	225	225	130	5

### a) Packing Structure

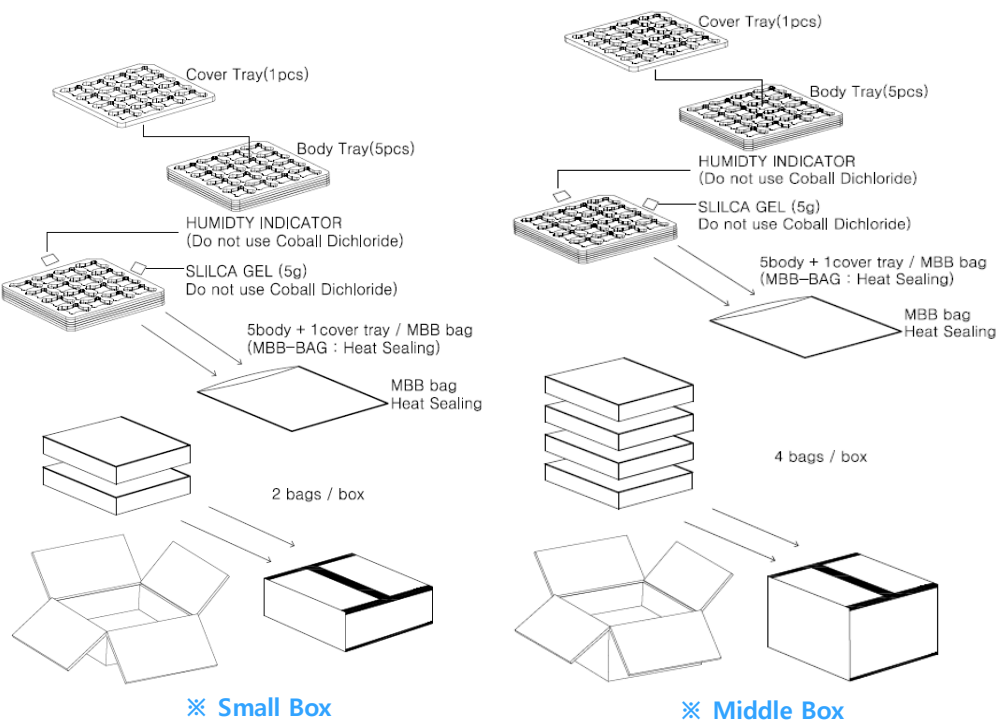

### b) Tray

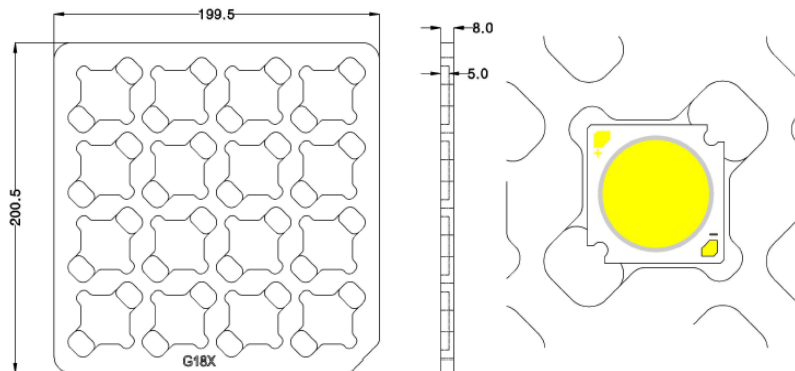

## 8. Precautions in Handling & Use

- 1) This device should not be used in any type of fluid such as water, oil, organic solvent, etc. When cleaning is required, IPA is recommended as the cleaning agent. Some solvent-based cleaning agent may damage the silicone resins used in the device.
- 2) LEDs must be stored in a clean environment. If the LEDs are to be stored for three months or more after being shipped from Samsung, they should be packed with a nitrogen-filled container (shelf life of sealed bags is 12 months at temperature 0~40 °C, 0~90 % RH).
- 3) After storage bag is opened, device subjected to soldering, solder reflow, or other high temperature processes must be:
  - a. Mounted within 672 hours (28 days) at an assembly line with a condition of no more than 30 °C / 60 % RH, or
  - b. Stored at <10 % RH
- 4) Repack unused products with anti-moisture packing, fold to close any opening and then store in a dry place.
- 5) Devices require baking before mounting, if humidity card reading is >60 % at 23 ± 5 °C.
- 6) Devices must be baked for 1 hour at 60 ± 5 °C, if baking is required.
- 7) The LEDs are sensitive to the static electricity and surge current. It is recommended to use a wrist band or anti-electrostatic glove when handling the LEDs. If voltage exceeding the absolute maximum rating is applied to LEDs, it may cause damage or even destruction to LED devices. Damaged LEDs may show some unusual characteristics such as increase in leakage current, lowered turn-on voltage, or abnormal lighting of LEDs at low current.
- 8) The thermal management is one of the most critical factors for the LED lighting system. Especially the LED junction temperature should not exceed the absolute maximum rating while operation of LED lighting system.  
For more information, please refer to Application Note 'Mechanical & Thermal Guide for COB'.
- 9) In case of driving LEDs around the minimum current level ( $I_{f\_min}$ ), chips might exhibit different brightness due to the variation in I-V characteristics of each one. This is normal and does not adversely affect the performance of product.
- 10) VOCs (Volatile Organic Compounds) can be generated from adhesives, flux, hardener or organic additives used in luminaires (fixtures). Transparent LED silicone encapsulant is permeable to those chemicals and they may lead to a discoloration of encapsulant when they exposed to heat or light. This phenomenon can cause a significant loss of light emitted (output) from the luminaires. In order to prevent these problems, we recommend users to know the physical properties of materials used in luminaires and they must be carefully selected.
- 11) The resin area is very sensitive, please do not handle, press, touch, rub, clean, or pick by with tweezers on it. Instead, please pick at the handling area as indicated below.

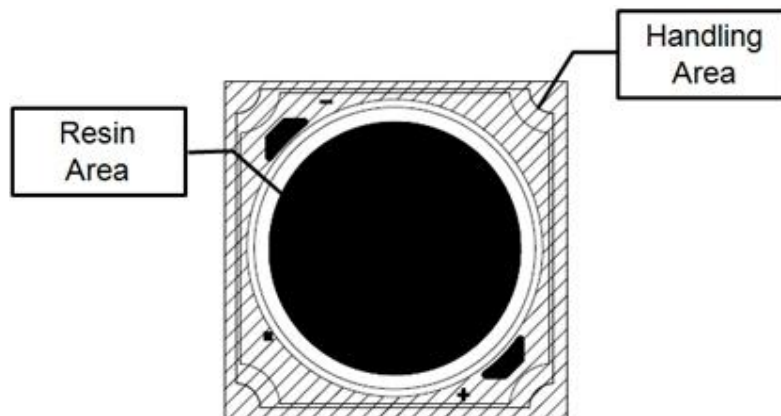

# Legal and additional information.

## About Samsung Electronics Co., Ltd.

Samsung Electronics Co., Ltd. inspires the world and shapes the future with transformative ideas and technologies, redefining the worlds of TVs, smartphones, wearable devices, tablets, cameras, digital appliances, printers, medical equipment, network systems and semiconductors. We are also leading in the Internet of Things space through, among others, our Digital Health and Smart Home initiatives. We employ 307,000 people across 84 countries. To discover more, please visit our official website at [www.samsung.com](http://www.samsung.com) and our official blog at [global.samsungtomorrow.com](http://global.samsungtomorrow.com).

Copyright © 2015 Samsung Electronics Co., Ltd. All rights reserved.  
Samsung is a registered trademark of Samsung Electronics Co., Ltd.  
Specifications and designs are subject to change without notice. Non-metric weights and measurements are approximate. All data were deemed correct at time of creation. Samsung is not liable for errors or omissions. All brand, product, service names and logos are trademarks and/or registered trademarks of their respective owners and are hereby recognized and acknowledged.

Samsung Electronics Co., Ltd.  
95, Samsung 2-ro  
Giheung-gu  
Yongin-si, Gyeonggi-do, 446-711  
KOREA

[www.samsungled.com](http://www.samsungled.com)

