

FLORENCE-1R-O

~95° + 30° oval beam

TECHNICAL SPECIFICATIONS:

Dimensions	285.6 x 19.5 mm
Height	7 mm
Fastening	glue, clips
Colour	clear
Box size	398 x 298 x 140 mm
Box weight	7.1 kg
Quantity in Box	210 pcs
ROHS compliant	yes ⓘ

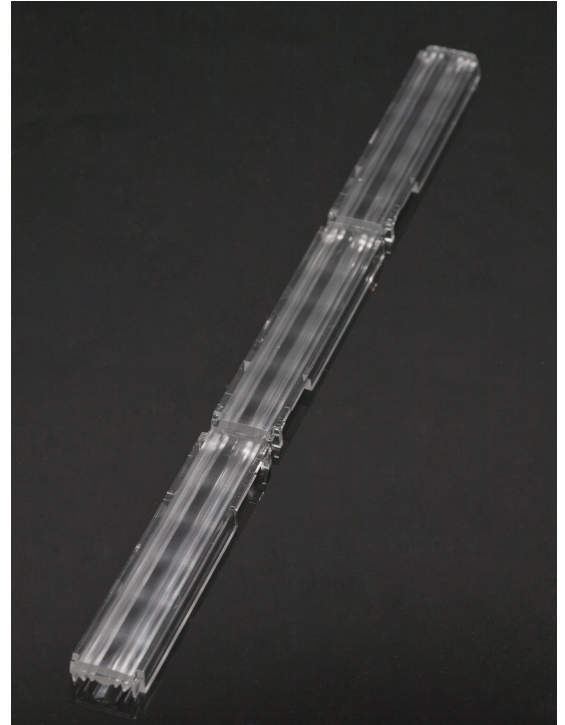

MATERIAL SPECIFICATIONS:

Component	Type	Material	Colour
FLORENCE-1R-O	Lens	PMMA	clear

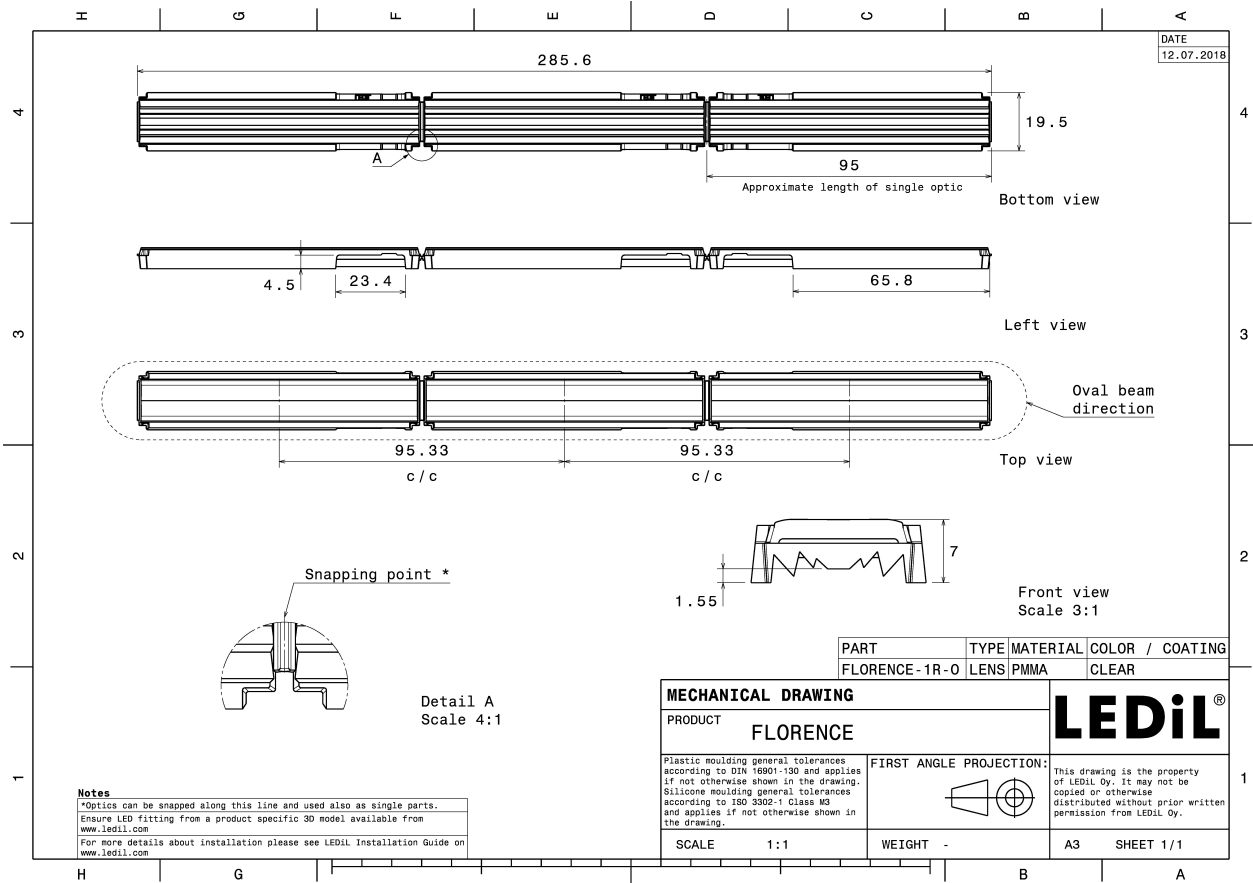

PHOTOMETRIC DATA (MEASURED):

CEZOS

LED L0-280024-xxx-C0800-L267
 FWHM 92.0 + 35.0°
 Efficiency 91 %
 Peak intensity 0.780 cd/lm
 Required components:

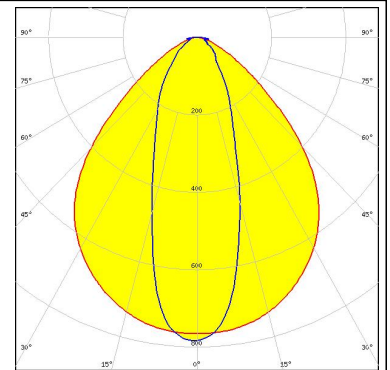
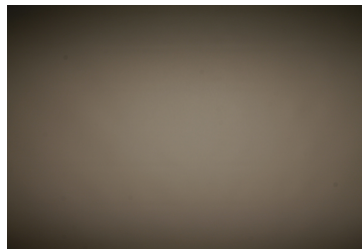

LUMILEDS

LED LUXEON 3014
 FWHM 98.0 + 33.0°
 Efficiency 93 %
 Peak intensity 1.030 cd/lm
 Required components:

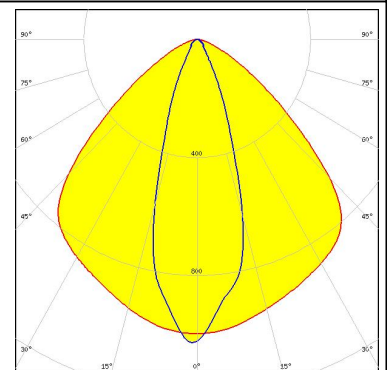
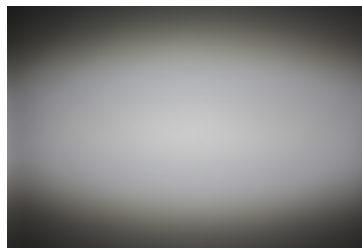

LUMILEDS

LED LUXEON 3020
 FWHM 95.0 + 31.0°
 Efficiency 93 %
 Peak intensity 1.060 cd/lm
 Required components:

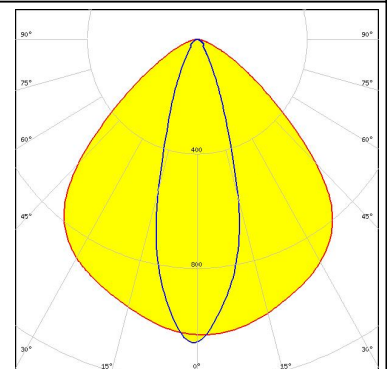
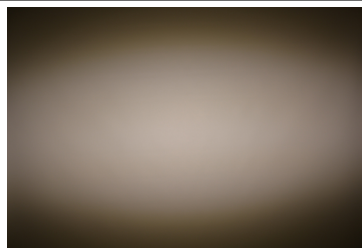

LUMILEDS

LED LUXEON 3030 2D (Round LES)
 FWHM 93.0 + 34.0°
 Efficiency 91 %
 Peak intensity 0.890 cd/lm
 Required components:

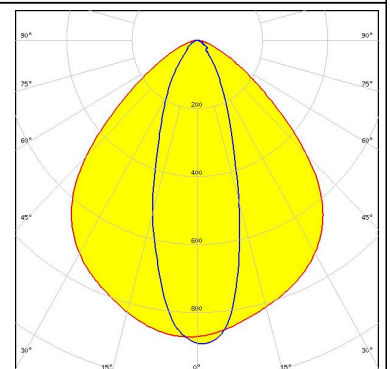
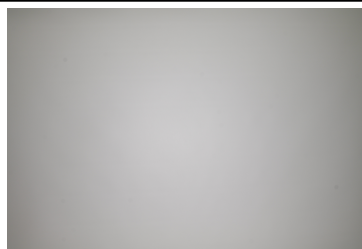

PHOTOMETRIC DATA (MEASURED):



LED LUXEON 3535L
FWHM 93.0 + 35.0°
Efficiency 93 %
Peak intensity 0.850 cd/lm
Required components:

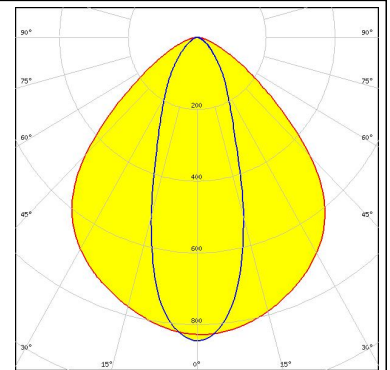

LED MP-2016
FWHM 94.0 + 31.0°
Efficiency 92 %
Peak intensity 1.100 cd/lm
Required components:

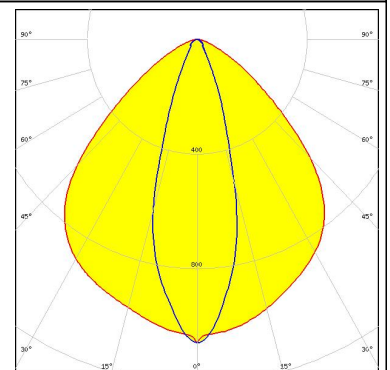
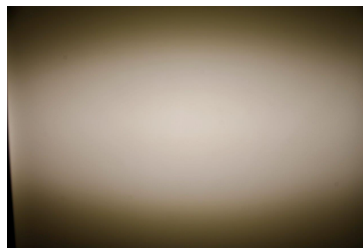

LED NF2x757D
FWHM 93.0 + 34.0°
Efficiency 94 %
Peak intensity 0.820 cd/lm
Required components:

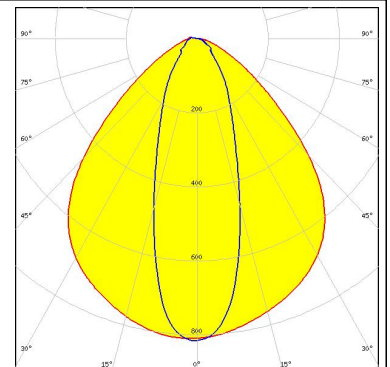
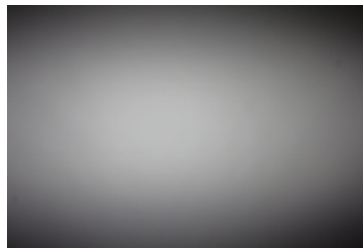

LED NF2x757G
FWHM 92.0 + 35.0°
Efficiency 90 %
Peak intensity 0.870 cd/lm
Required components:

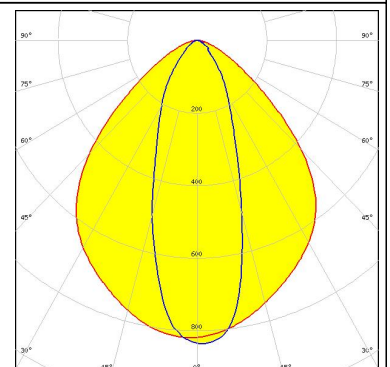
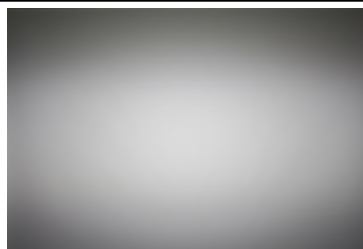

PHOTOMETRIC DATA (MEASURED):

OSRAM
Opto Semiconductors

LED Duris S5 (2 chip)
FWHM 92.0 + 33.0°
Efficiency 91 %
Peak intensity 0.850 cd/lm
Required components:

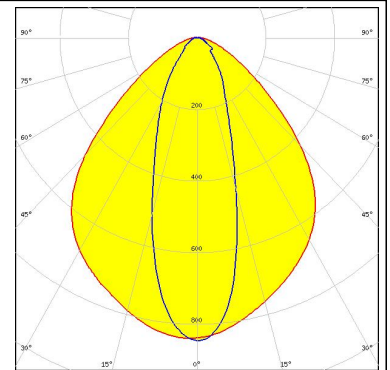

PHILIPS

LED Fortimo LED Line 1ft 1100lm xx0 1R xv2/x
FWHM 96.0 + 32.0°
Efficiency 94 %
Peak intensity 0.900 cd/lm
Required components:

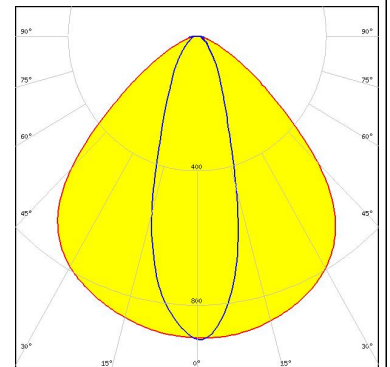
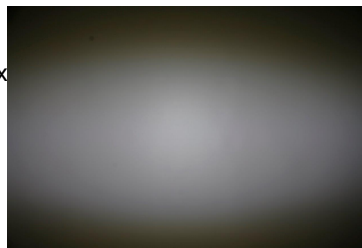

PHILIPS

LED Fortimo LED Line 1ft 2000lm 8x0 1R HV1/1
FWHM 95.0 + 31.0°
Efficiency 94 %
Peak intensity 0.910 cd/lm
Required components:
C14353_FLORENCE-1R-CLIP-A

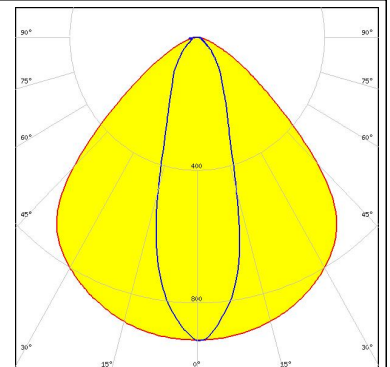
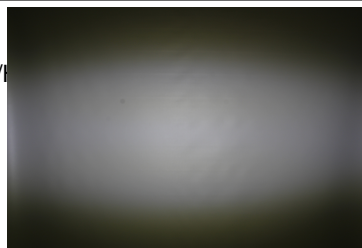

SAMSUNG

LED LM28xB Series
FWHM 94.0 + 34.0°
Efficiency 93 %
Peak intensity 0.880 cd/lm
Required components:

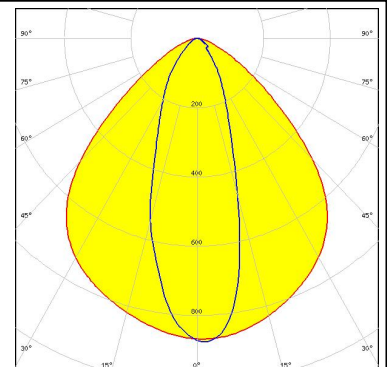
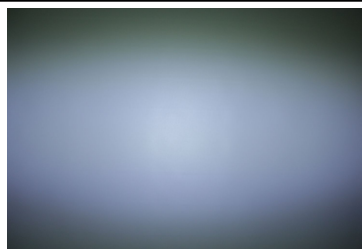

PHOTOMETRIC DATA (MEASURED):

SAMSUNG

LED LM301A
FWHM 93.0 + 32.0°
Efficiency 92 %
Peak intensity 0.975 cd/lm
Required components:

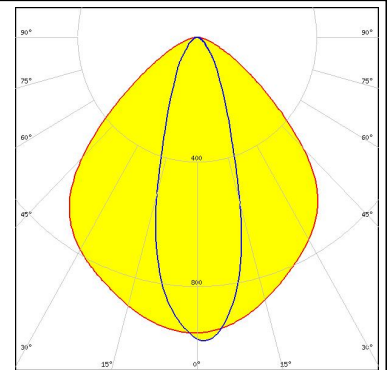

SAMSUNG

LED LM302A
FWHM 92.0 + 34.0°
Efficiency 92 %
Peak intensity 0.880 cd/lm
Required components:

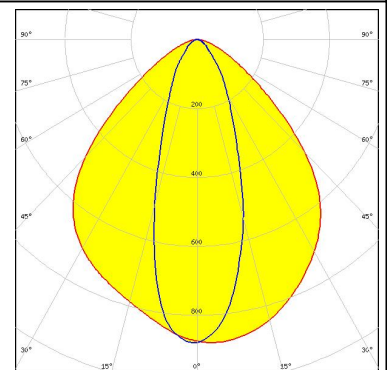

SAMSUNG

LED LM561C
FWHM 94.0 + 32.0°
Efficiency 93 %
Peak intensity 0.930 cd/lm
Required components:

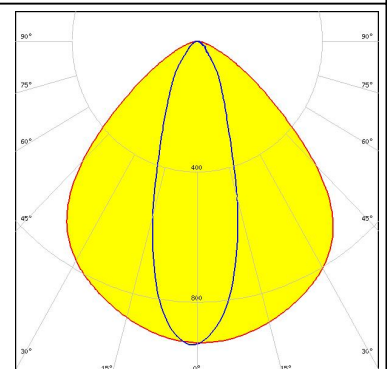
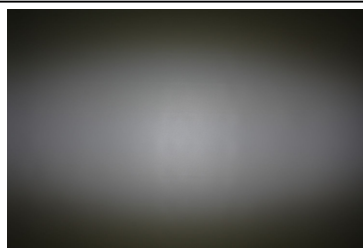



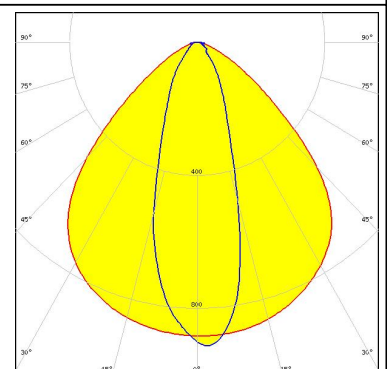
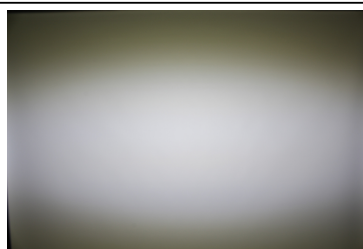

SAMSUNG

LED LT-S282N
FWHM 95.0 + 32.0°
Efficiency 93 %
Peak intensity 0.910 cd/lm
Required components:

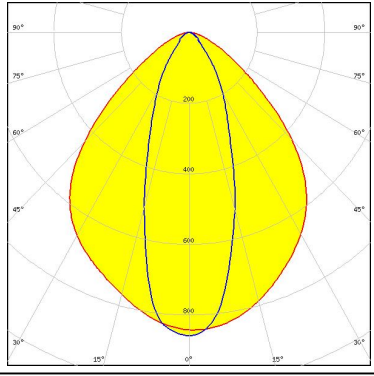

PHOTOMETRIC DATA (MEASURED):

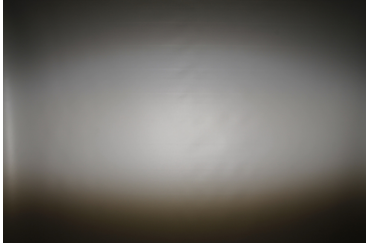
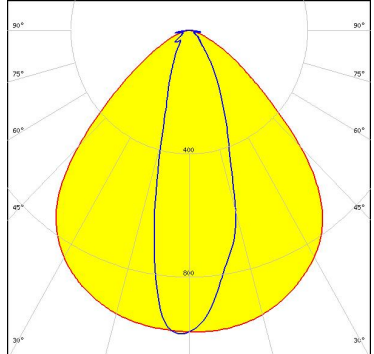
<p> SEOUL SEMICONDUCTOR</p> <p>LED SEOUL 3030 FWHM 91.0 + 35.0° Efficiency 90 % Peak intensity 0.860 cd/lm Required components:</p>		
<p> SEOUL SEMICONDUCTOR</p> <p>LED SunLike 3030 FWHM 92.0 + 30.0° Efficiency 94 % Peak intensity 0.990 cd/lm Required components: C14353_FLORENCE-1R-CLIP-A</p>		

PHOTOMETRIC DATA (SIMULATED):



LED LUXEON CZ
FWHM 95.0 + 33.0°
Efficiency 94 %
Peak intensity 1.080 cd/lm
Required components:

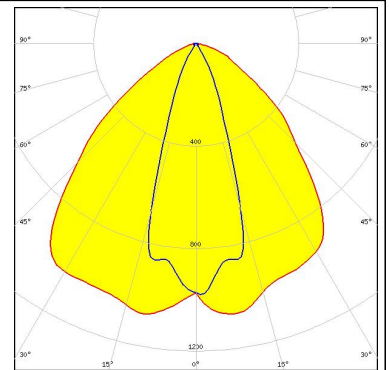

LED Duris E 2835
FWHM 92.0 + 30.0°
Efficiency 94 %
Peak intensity 0.950 cd/lm
Required components:

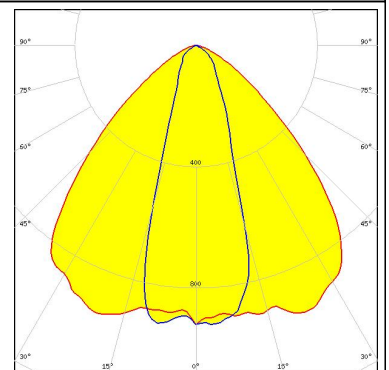

LED Duris E5
FWHM 92.0 + 32.0°
Efficiency 94 %
Peak intensity 0.950 cd/lm
Required components:

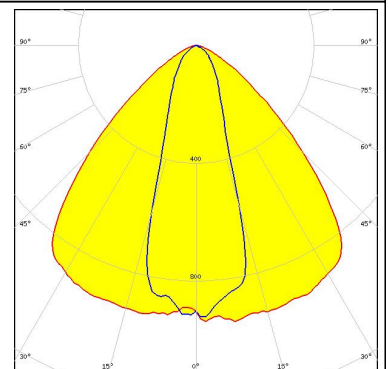

GENERAL INFORMATION:

NOTE: The typical beam angle will be changed by different color, chip size and chip position tolerance. The typical total beam angle is the full angle measured where the luminous intensity is half of the peak value.

MATERIALS:

As part of our continuous research and improvement processes, and to ensure the best possible quality and availability of our products, LEDiL reserves the right to change material grades without notice.

PRODUCT DATA USER AGREEMENT AND DISCLAIMER:

The measured data in the provided downloadable LEDiL Product Datasheets and Mechanical 2D-Drawings is rounded and provided as reference for planning. LEDiL Oy's optical specifications have been verified by conducting performance testing of the products in accordance with the company's quality system. The reported data are averaged results of multiple measurements with typical variation. LEDiL Oy reserves the right to without prior notification make changes and improvements to its products.

LEDiL Oy assumes neither warranty, nor guarantee nor any other liability of any kind for the contents and correctness of the provided data. The provided data has been generated with highest diligence but the provided data may in reality not represent the complete possible variation range of all intrinsic parameters. Therefore, in certain cases a deviation from the provided data could occur.

LEDiL Oy reserves the right to undertake technical changes of its products without further notification which could lead to changes in the provided data. LEDiL Oy assumes no liability of any kind for the possible deviation from any provided data or any other damage resulting from the usage of the provided data.

The user agrees to this disclaimer and user agreement with the download or usage of the provided files.

LEDiL Oy

Joensuunkatu 13
FI-24240 SALO
Finland

LEDiL Inc.

228 West Page Street
Suite D
Sycamore IL 60178
USA

Local sales and technical support

[www.ledil.com/
where_to_buy](http://www.ledil.com/where_to_buy)

Shipping locations

Salo, Finland
Hong Kong, China

Distribution Partners

[www.ledil.com/
where_to_buy](http://www.ledil.com/where_to_buy)