

Solid State Relays 1-Phase with Integrated Heatsink Proportional Switching Controllers Types RGC1P..AA., RGC1P..V..



- 1-pole analog switching AC solid state contactors
- Selectable mode of operation:
 - Phase Angle
 - Full Cycle x1, x4, x16
 - Advanced Full Cycle
 - Soft Starting
- Rated operational voltage: up to 660 VAC
- Rated operational current: up to 63 AAC
- Control inputs: 4-20 mA, 0-5 V, 1-5 V, 0-10 V, external potentiometer
- Integrated varistor protection on output
- Load ON LED indication
- 100kA short circuit current rating according to UL508
- DIN or panel mount



Product Description

The RGC1P is a series of solid state contactors (with integrated heatsink) that give the possibility to control output power of 1-phase loads with an analog control input. Input types cover a wide range of current and voltage ranges. Local setting by an external potentiometer is possible. Switching modes, selectable through a front knob, allow phase angle control, full cycle control,

advanced full cycle control specific for short wave infrared heaters and soft starting for limiting inrush current of loads having a high temperature coefficient.

The output of the RGC1P is protected against overvoltages by means of an integrated varistor across the output. Two front LEDs indicate the status of the load and control.

Specifications are at a surrounding temperature of 25°C unless otherwise specified.

Ordering Key **RGC 1 P 60 V 42 E D**

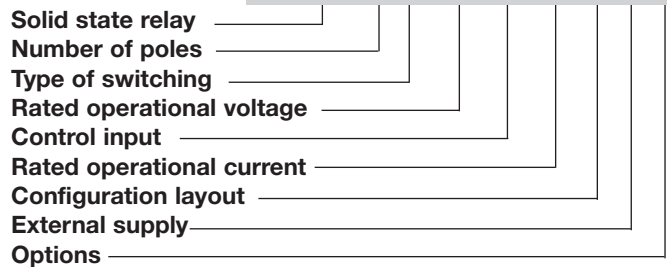

Type Selection

| SSR with heatsink | Type of switching | Rated voltage (Ue), Blocking voltage | Control input ¹ | Rated current ² @40°C, I ² t | Connection configuration | External supply (Us) | Options |
|------------------------|-------------------|--------------------------------------|------------------------------------|--|--------------------------|-----------------------------------|---|
| RGC1: 1-pole switching | P: Proportional | 23: 85 - 265 VAC, 800 Vp | AA: 4-20 mADC | 12: 15 AAC, 1800 A ² s 30: 30 AAC, 1800 A ² s 42: 43 AAC, 18000 A ² s | E: Contactor | D: 24 VDC / AC A: 90 - 250 VAC | T: Tamper proof cover & securness tie included in packaging |
| | | 48: 190 - 550 VAC, 1200 Vp | V: 0-5 VDC 1- 5 VDC | 50: 50 AAC, 3200 A ² s 62: 63 AAC, 18000 A ² s | | | |
| | | 60: 410 - 660 VAC, 1200 Vp | 0-10 VDC External potentiometer | | | | |

1: 'V' control input versions require an external supply Us
2: Refer to Current Derating

Selection Guide

| Output voltage, Ue | Control input | External supply, Us | Power connection | Rated operational current @ 40°C (Pst) | | | | | |
|--|--|-------------------------|------------------|--|-------------------------------|--------------------------------|-------------------------------|--------------------------------|--------------|
| | | | | Product width | | | | | |
| | | | | 15 AAC (1800 A²s) 35 mm | 30 AAC (1800 A²s) 35 mm | 43 AAC (18000 A²s) 35 mm | 50 AAC (3200 A²s) 70 mm | 63 AAC (18000 A²s) 70 mm | |
| 85 - 265 VAC | AA: 4-20 mADC | - | Screw | RGC1P23AA12E | RGC1P23AA30E | - | - | - | |
| | | | Box | - | - | RGC1P23AA42E RGC1P23AA42ET | RGC1P23AA50E | RGC1P23AA62E | |
| | V: 0-10V, 0-5V, 1-5VDC, pot | 24 VDC/AC | Screw | RGC1P23V12ED | RGC1P23V30ED | - | - | - | |
| | | | Box | - | - | RGC1P23V42ED RGC1P23V42EDT | RGC1P23V50ED | RGC1P23V62ED | |
| | 90-250 VAC | - | Screw | RGC1P23V12EA | RGC1P23V30EA | - | - | - | |
| | | | Box | - | - | RGC1P23V42EA | - | RGC1P23V62EA | |
| | 190 - 550 VAC | AA: 4-20 mADC | - | Screw | RGC1P48AA12E | RGC1P48AA30E | - | - | - |
| | | | | Box | - | - | RGC1P48AA42E RGC1P48AA42ET | RGC1P48AA50E | RGC1P48AA62E |
| V: 0-10V, 0-5V, 1-5VDC, pot | | 24 VDC/AC | Screw | RGC1P48V12ED | RGC1P48V30ED | - | - | - | |
| | | | Box | - | - | RGC1P48V42ED | RGC1P48V50ED | RGC1P48V62ED | |
| 90-250 VAC | | - | Screw | RGC1P48V12EA | RGC1P48V30EA | - | - | - | |
| | | | Box | - | - | RGC1P48V42EA | - | RGC1P48V62EA | |
| 410 - 660 VAC | | AA: 4-20 mADC | - | Screw | - | RGC1P60AA30E | - | - | - |
| | | | | Box | - | - | RGC1P60AA42E | - | RGC1P60AA62E |
| | V: 0-10V, 0-5V, 1-5VDC, pot | 24 VDC/AC | Screw | - | RGC1P60V30ED | - | - | - | |
| | | | Box | - | - | RGC1P60V42ED | - | RGC1P60V62ED | |
| | 90-250 VAC | - | Screw | - | RGC1P60V30EA | - | - | - | |
| | | | Box | - | - | RGC1P60V42EA | - | RGC1P60V62EA | |

General Specifications

| | RGC1P..AA | RGC1P..V |
|--|---|--|
| Operational frequency range | 45 to 65 Hz | 45 to 65 Hz |
| Power factor | > 0.7 @ rated voltage | > 0.7 @ rated voltage |
| Touch Protection | IP20 | IP20 |
| LED status indication ³ | | |
| | Green | Control input <4 mA, flashing 0.5s ON, 0.5s OFF >4 mA, fully on, intensity varies with input |
| | | Control input 0 V, flashing 0.5s ON, 0.5s OFF >0 V, fully ON |
| | | Supply ON (Us) n/a |
| | | Supply ON (Us) Flashing 0.5s ON, 0.5s OFF |
| | Yellow | Load ON |
| | | Load ON |
| Pollution degree | 2 (non-conductive pollution with possibilities of condensation) | 2 (non-conductive pollution with possibilities of condensation) |
| Rated impulse withstand voltage, Uimp | 6 kV (1.2/50µs) | 6 kV (1.2/50µs) |
| Over-voltage category | III (fixed installations) | III (fixed installations) |
| Isolation | | |
| L1, T1, A1, A2, A3, POT, GND, Us to case | 4000 Vrms | 4000 Vrms |
| L1, T1 to A1, A2, A3, Pot, GND, Us | 2500 Vrms | 2500 Vrms |
| Us to A1, A2, A3, POT, GND | n/a | n/a (..V..ED) 1500 Vrms (..V..EA) |

3: Refer to LED Indications section

Output Voltage Specifications

| | RGC1P23.. | RGC1P48.. | RGC1P60.. |
|---------------------------------|------------|-------------|-------------|
| Operational voltage range (Ue) | 85-265 VAC | 190-550 VAC | 410-660 VAC |
| Blocking voltage | 800 Vp | 1200 Vp | 1200 Vp |
| Leakage current @ rated voltage | ≤ 5 mAAC | ≤ 5 mAAC | ≤ 5 mAAC |
| Internal Varistor across output | Yes | Yes | Yes |

Output Specifications

| | RGC1P..12 | RGC1P..30 | RGC1P..42 | RGC1P..50 | RGC1P..62 |
|---|----------------------------|----------------------------|----------------------------|----------------------------|----------------------------|
| Rated operational current per pole ⁴ AC-51 @ Ta=25 °C AC-51 @ Ta=40 °C AC-55b @ Ta=40 °C ⁵ | 18 AAC 15 AAC 15 AAC | 30 AAC 30 AAC 30 AAC | 50 AAC 43 AAC 43 AAC | 58 AAC 50 AAC 50 AAC | 73 AAC 63 AAC 63 AAC |
| Minimum operational current | 250 mAAC | 250 mAAC | 500 mAAC | 500 mAAC | 500 mAAC |
| No. of starts ⁵ | 500 | 15 | 200 | 6 | 350 |
| Rep. Overload Current PF = 0.7 UL508: T=40°C, t _{ON} =1s, t _{OFF} =9s, 50 cycles | 51 AAC | 84 AAC | 126 AAC | 126 AAC | 168 AAC |
| Maximum transient surge current (I _{TSM}), t=10ms | 600 Ap | 600 Ap | 1900 Ap | 800 Ap | 1900 Ap |
| I ² t for fusing (t=10ms), minimum | 1800 A ² s | 1800 A ² s | 18000 A ² s | 3200 A ² s | 18000 A ² s |
| Critical dv/dt (@ T _j init = 40°C) | 1000 V/μs | 1000 V/μs | 1000 V/μs | 1000 V/μs | 1000 V/μs |

4: refer to Current Derating

5: Overload profile for AC-55b, I_e: AC-55b: 6x I_e - 0.2: 50 - x; where I_e = nominal current (AAC), 0.2 is the duration of the overload (6xI_e) in seconds, 50 is the duty cycle in %, and x = no. of starts. The overload profile for RGC1P..62 is AC-55b:4.7xI_e - 0.2 : 50-x

Supply Specifications

| | RGC1P..V..D | RGC1P..V..A |
|--|--|-----------------|
| Supply voltage range (Us) ⁶ | 24 VDC, -15% / +20% 24 VAC, -15% / +15% | 90-250 VAC - |
| Overvoltage protection | up to 32 VDC/AC for 30 sec. | n/a |
| Reverse Protection | Yes | n/a |
| Surge Protection ⁷ | Yes, integrated | Yes, integrated |
| Max. supply current | 30 mA | 14 mA |

6. 24 VAC/DC to be supplied from a Class 2 power source

7. Refer to Electromagnetic Compatibility section



Input Specifications

| | RGC1P..AA | RGC1P..V |
|--|---|---|
| Control input | 4-20 mADC (A1-A2) | 0-10 VDC (A1-GND) 0-5 VDC (A2-GND) 1-5 VDC (A3-GND) |
| Pickup current, minimum | 4.3 mADC | - |
| Drop out current | 3.9 mADC | - |
| Pick up voltage 0-5 VDC, 0-10 VDC range 1-5 VDC range | - - | 0.5 VDC 1.5 VDC |
| Drop out voltage 0-5 VDC, 0-10 VDC range 1-5 VDC range | - - | 0.05 VDC 1.02 VDC |
| Potentiometer input | - | 10k ohms (GND - A2 - POT) |
| Maximum initialisation time | 280 ms | 250 ms |
| Response time (Input to Output) Modes 1, 5, 7 Modes 2, 3, 4, 6 | 2 half cycles 3 half cycles | 2 half cycles 3 half cycles |
| Voltage drop | <10 VDC @ 20 mA | n/a |
| Input impedance | n/a | 100k ohms |
| Linearity (Output resolution) | Refer to Transfer Characteristics section, note 9 | |
| Reverse protection | Yes | Yes |
| Maximum allowable input current | 50 mA for max. 30 sec | - |
| Input protection vs. surges ⁸ | Yes | Yes |
| Overtoltage protection | - | up to 30 VDC |

8. Refer to Electromagnetic Compatibility section

9. The RGx1P is intended for use in closed loop systems where the output power automatically adjusts to the control input available from the system.

Transfer Characteristics

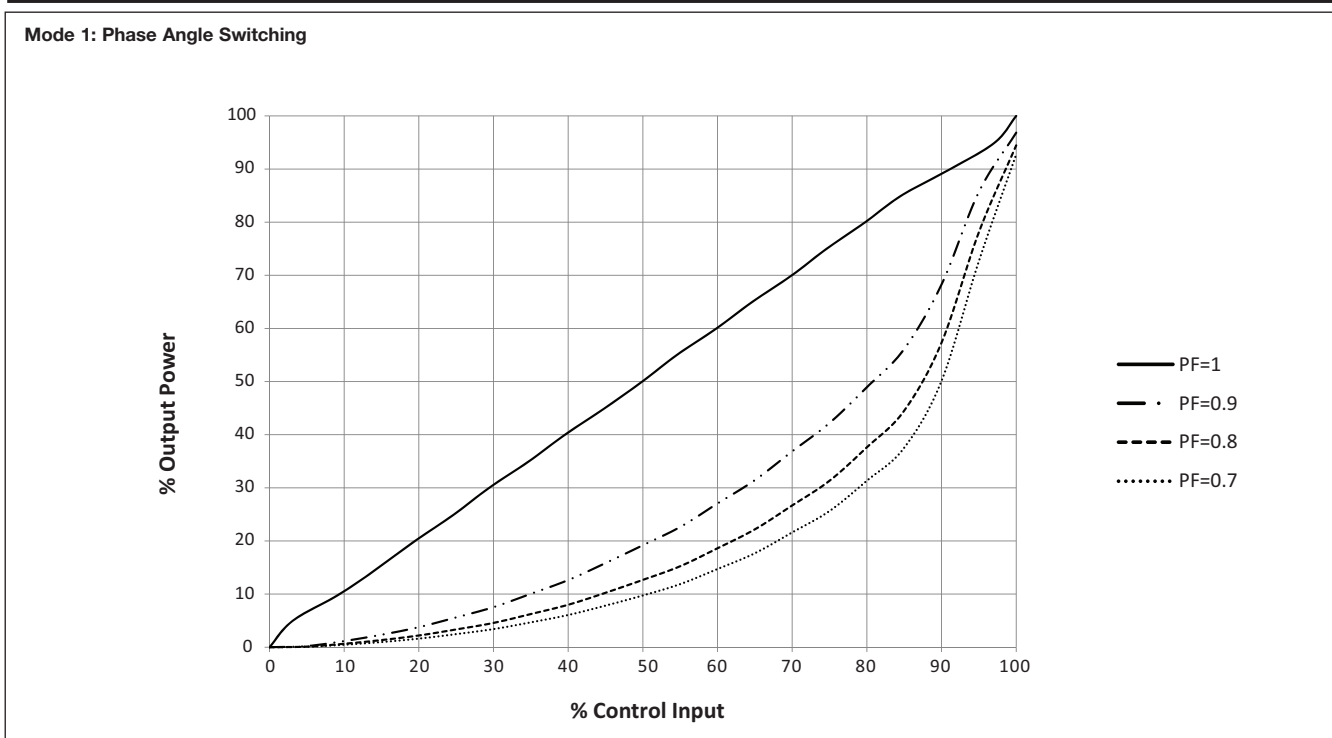

Transfer Characteristics (cont.)

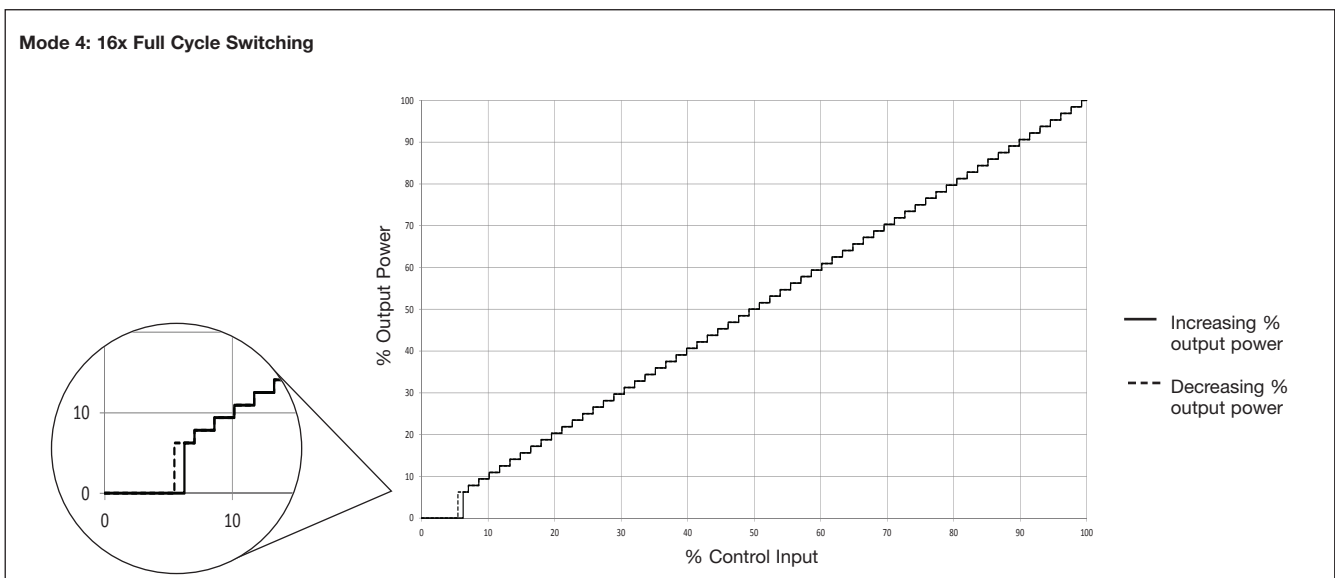
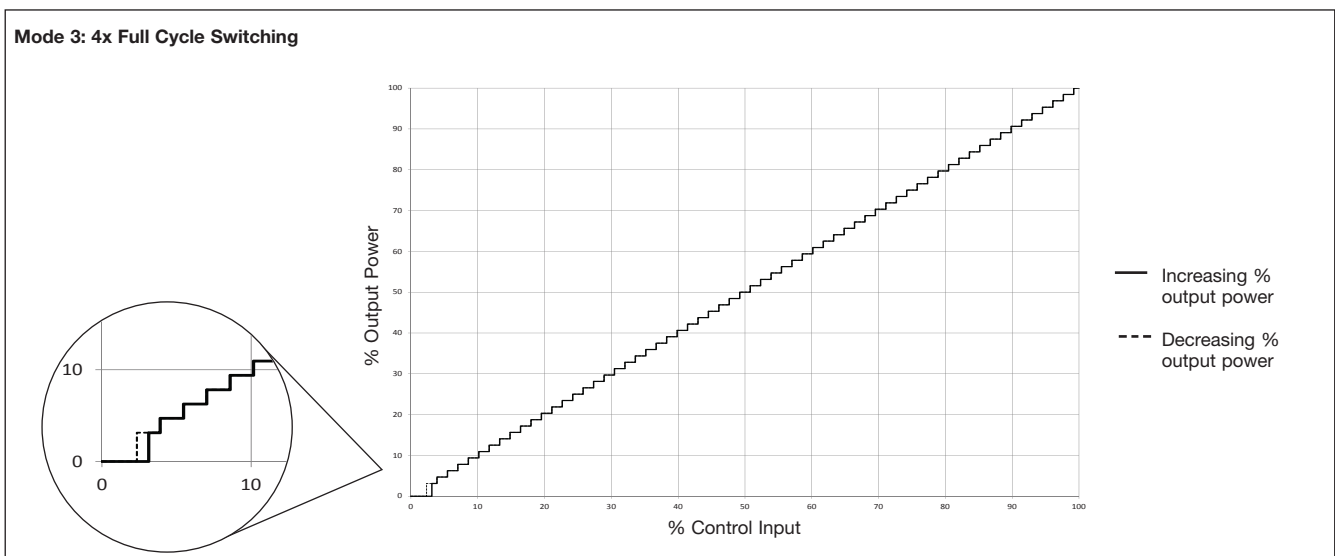
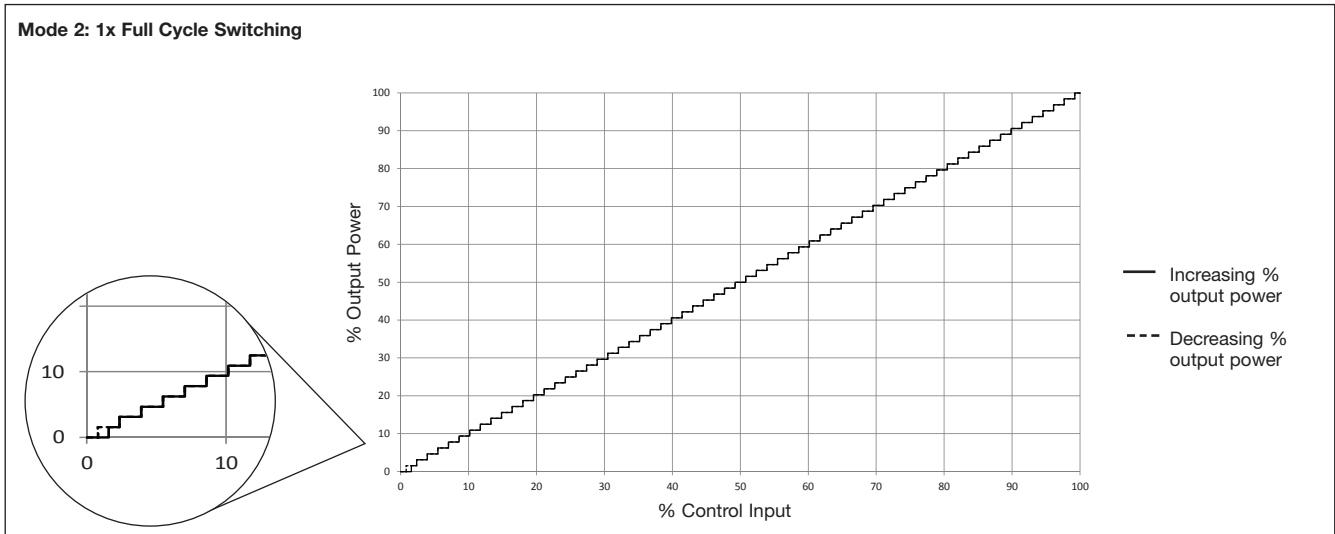



Output Power Dissipation

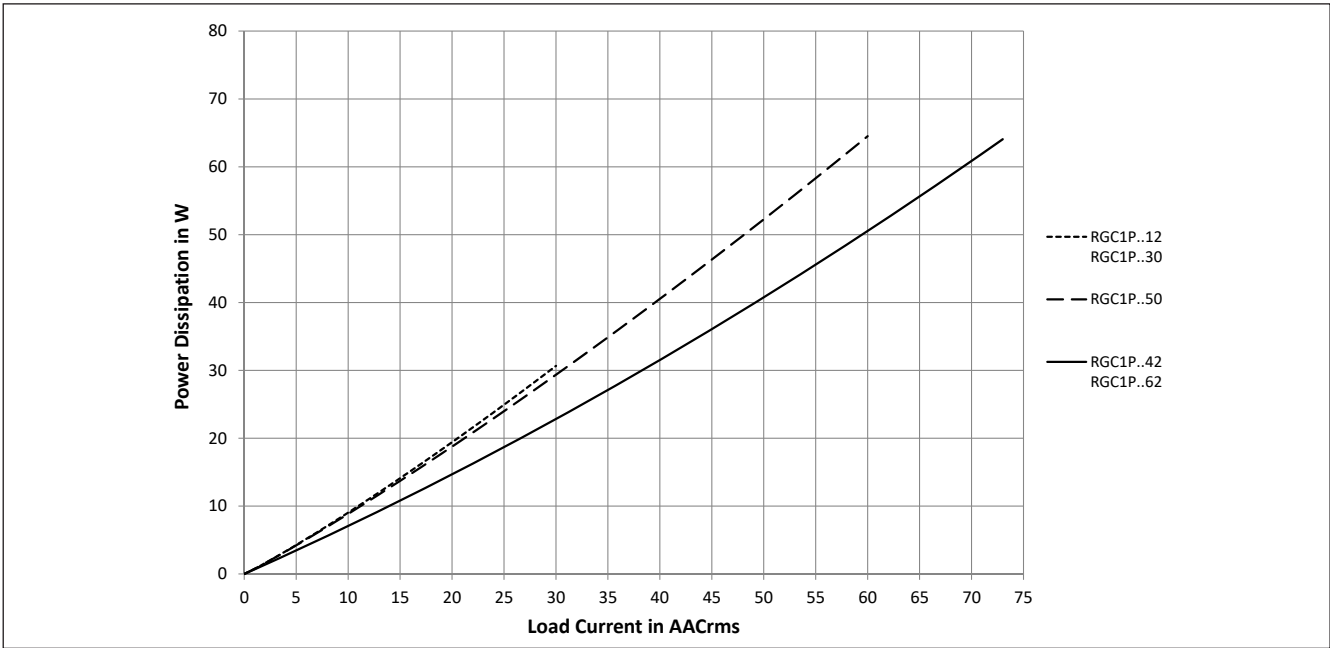

Current Derating (UL 508)

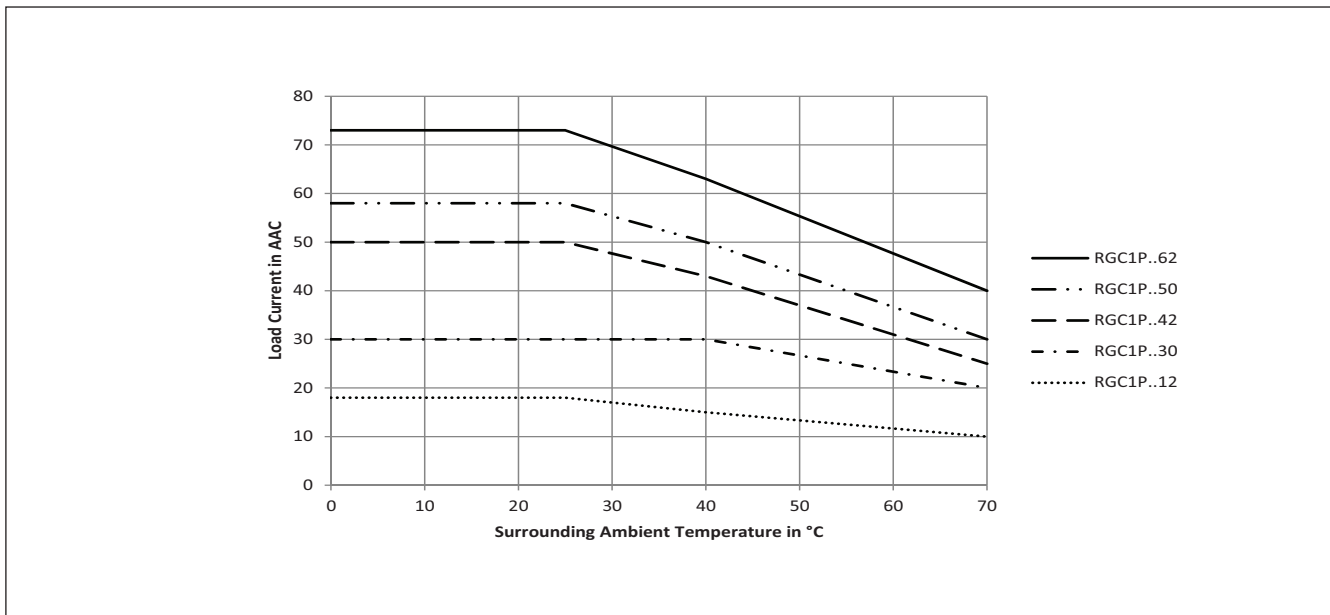

Current Derating vs. Spacing Curves

RGC1P..12

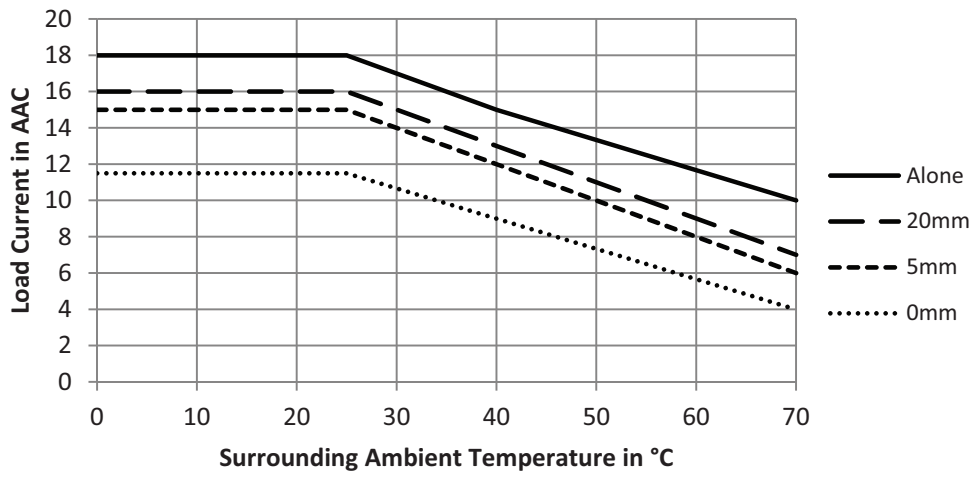

RGC1P..30

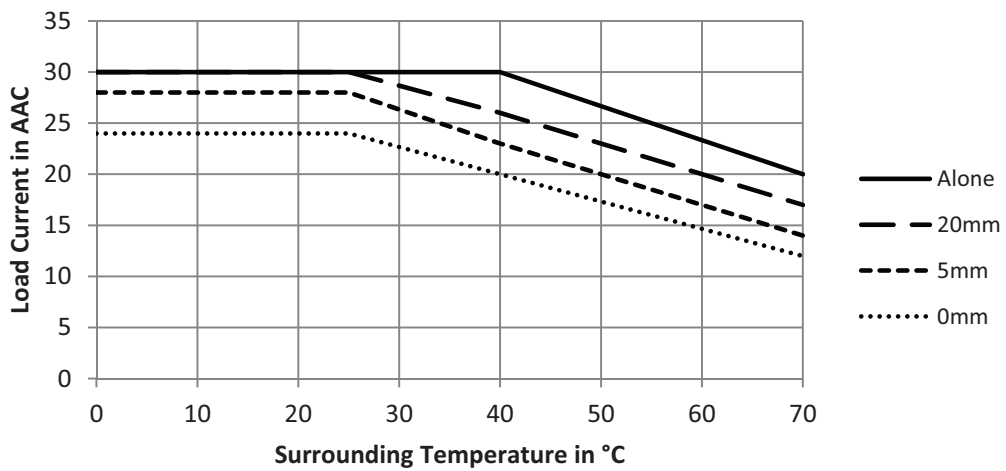

Current Derating vs. Spacing Curves

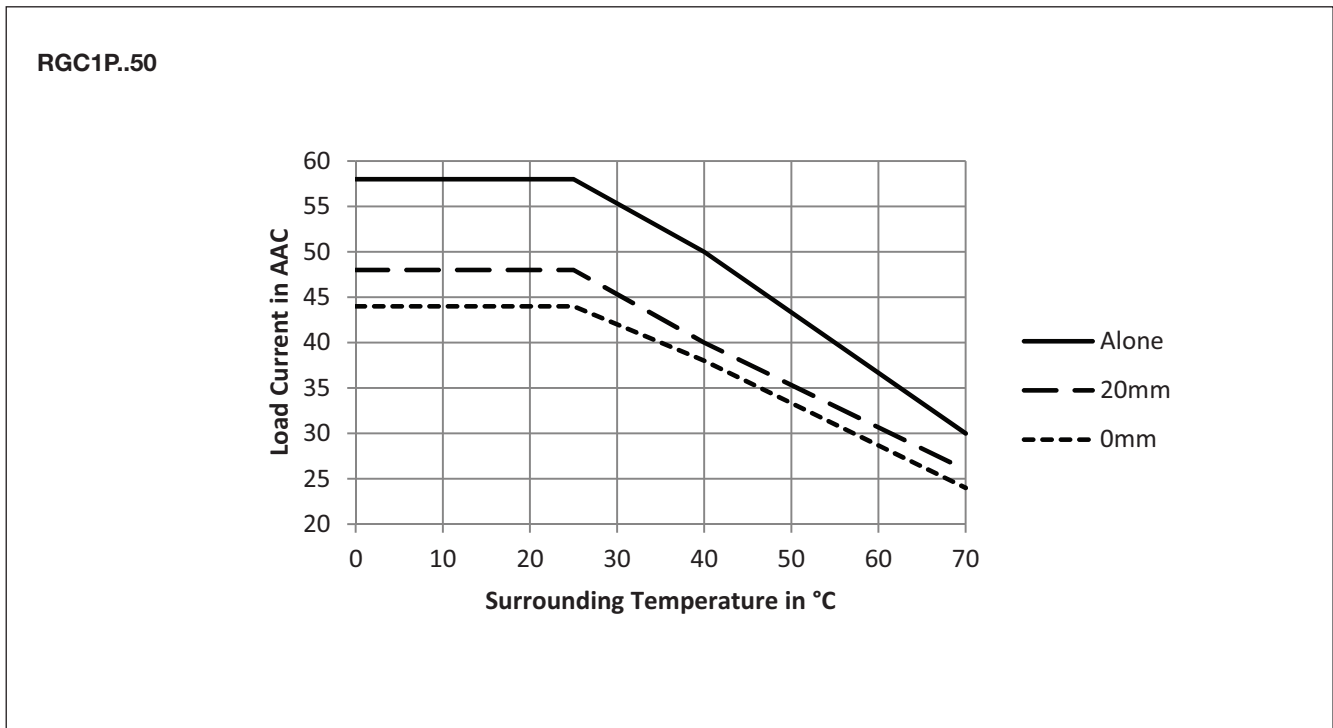
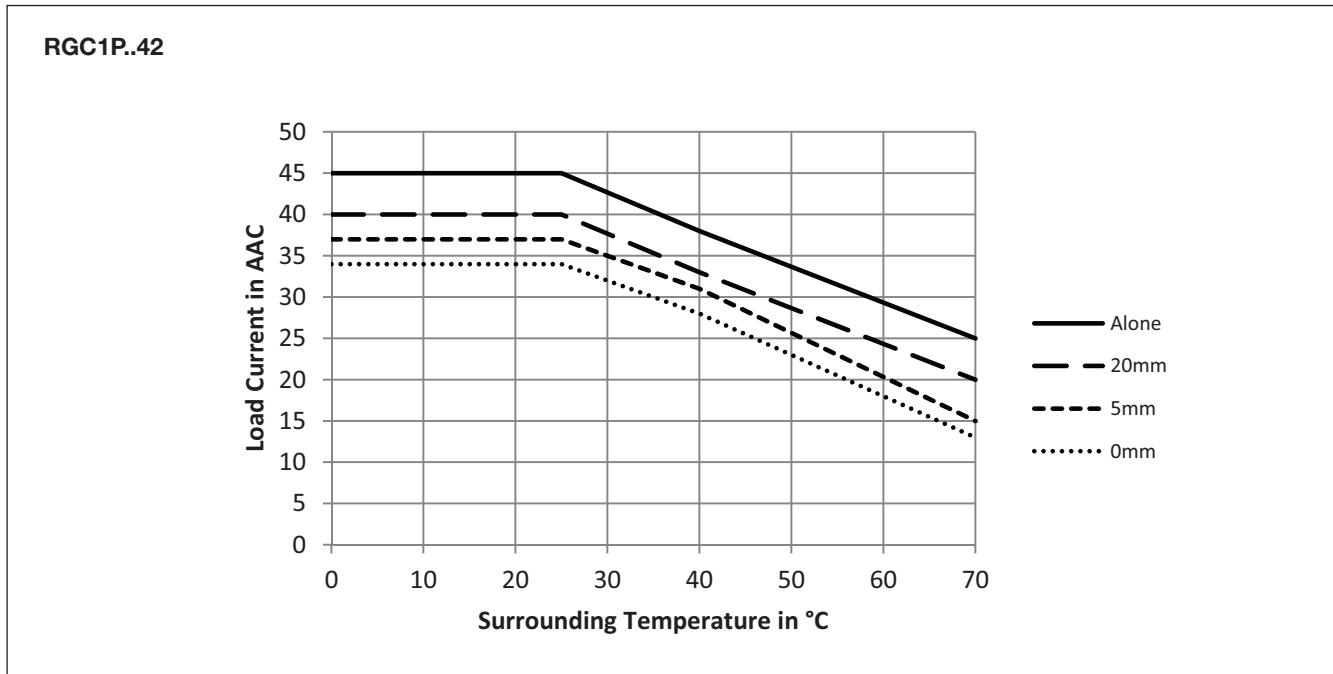

Current Derating vs. Spacing Curves

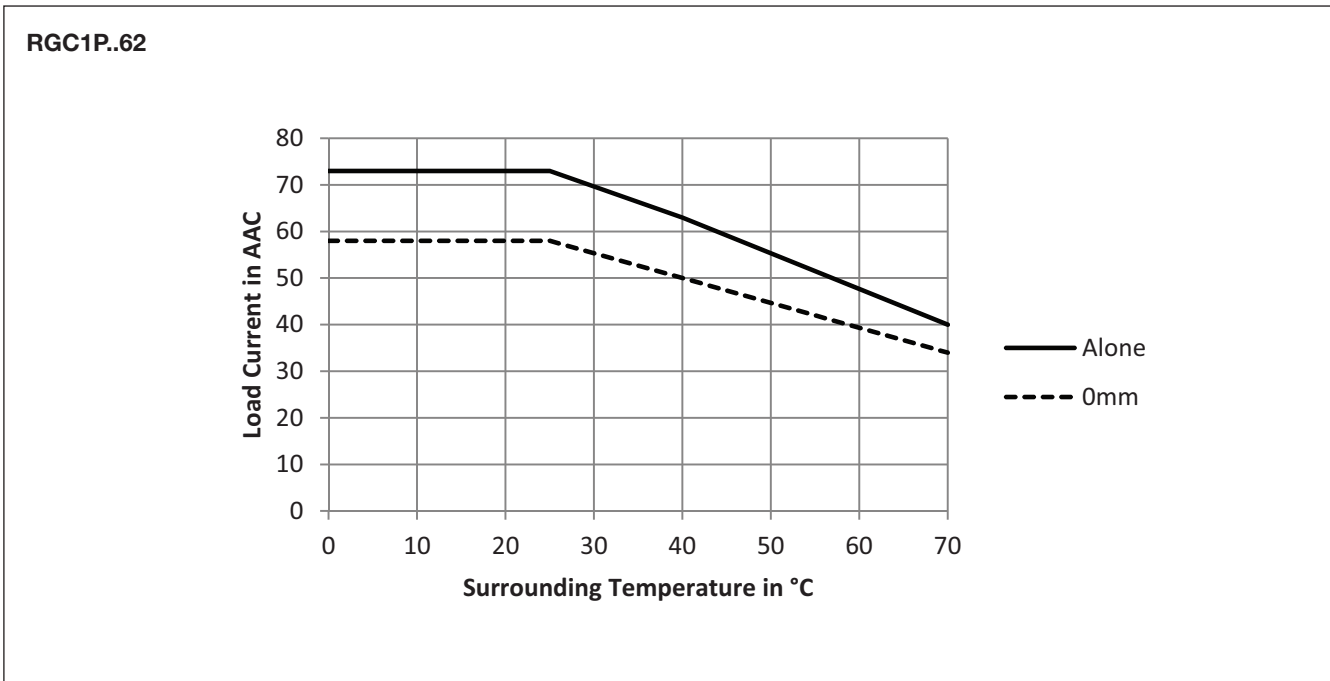

Environmental and Housing Specifications

| | | | |
|--|--|--------------------------------------|--|
| Operating Temperature | -40°C to +70°C (-40°F to +158°F) | UL flammability rating (for plastic) | UL 94 V0 Glow wire ignition temperature and Glow wire flammability index conform to EN 60335-1 requirements |
| Storage Temperature | -40°C to +100°C (-40°F to +212°F) | | |
| EU RoHS compliant | Yes | | |
| China RoHS compliant | Refer to Environmental Information (page 23) | Installation altitude | 0-1000m. Above 1000m derate linearly by 1% of FLC per 100m up to a maximum of 2000m |
| Impact resistance (EN50155, EN61373) | 15/11 g/ms | | |
| Vibration resistance (2-100Hz, IEC60068-2-6, EN50155, EN61373) | 2g per axis | | |
| Relative humidity | 95% non-condensing @ 40°C | Weight | approx. 225g |
| Material | PA66, RAL7035 | | |
| | | RGC1P..12 | approx. 460g |
| | | RGC1P..30, 42 | approx. 815g |
| | | RGC1P..50, 62 | |

Agency Approvals and Conformances

| | | | |
|--------------------|------------------|-------------------------------------|--|
| Conformance | IEC/EN 60947-4-3 | Agency Approvals | UL Listed: UL508, NMFT E172877 cUL Listed: CSA 22.2 No.14-13, NMFT7 E172877 |
| | | Short Circuit Current Rating | 100kArms, UL508 |



Electromagnetic Compatibility

| | | | |
|---|---|---|---|
| EMC Immunity | EN 60947-4-3 | Electrical fast transient (Burst) immunity | EN/IEC 61000-4-4 Performance Criteria 1 |
| Electrostatic discharge (ESD) immunity | EN/IEC 61000-4-2 Performance Criteria 2 | Output: 2kV, 5 kHz RGC1P..AA.. A1, A2: 2 kV, 5 kHz | Performance Criteria 1 |
| Air discharge, 8 kV Contact, 4 kV | Performance Criteria 2 | RGC1P..V.. A1, A2, A3, POT, GND: 1 kV, 5 kHz Us: 2 kV, 5 kHz | Performance Criteria 1 |
| Electrical surge immunity | EN/IEC 61000-4-5 Performance Criteria 2 | Radiated radio frequency immunity | EN/IEC 61000-4-3 Performance Criteria 1 |
| Output, line to line, 1 kV Output, line to earth, 2 kV | Performance Criteria 2 | 10V/m, 80 - 1000 MHz 10V/m, 1.4 - 2.0 GHz 3V/m, 2.0 - 2.7 GHz | Performance Criteria 1 |
| A1, A2 RGC1P..AA.. | Performance Criteria 2 | Conducted radio frequency immunity | EN/IEC 61000-4-6 Performance Criteria 1 |
| Line to line, 500 V Line to earth, 500 V | Performance Criteria 2 | 10V/m, 0.15 - 80 MHz | Performance Criteria 2 |
| A1, A2, A3, POT, GND RGC1P..V.. | Performance Criteria 2 | Voltage Dips | EN/IEC 61000-4-11 Performance Criteria 2 |
| Line to earth, 1 kV Us +, Us - | Performance Criteria 2 | 0% for 0.5, 1 cycle 40% for 10 cycles 70% for 25 cycles 80% for 250 cycles | Performance Criteria 2 |
| RGC1P..V..ED | Performance Criteria 2 | Voltage Interruptions | EN/IEC 61000-4-11 Performance Criteria 2 |
| Line to line, 500 V Line to earth, 500 V Us ~ | Performance Criteria 2 | 0% for 5000 ms | |
| RGC1P..V..EA | Performance Criteria 2 | | |
| Line to line, 1 kV Line to earth, 2 kV | Performance Criteria 2 | | |
| EMC Emission | EN 60947-4-3 | Radio interference field emission (radiated) | EN/IEC 55011 Class A (industrial) |
| Radio interference voltage emission (conducted) | EN/IEC 55011 Class A (with external filtering) | 30 - 1000 MHz | |
| 0.15 - 30 MHz | | | |

Note:

- Control input lines must be installed together to maintain products susceptibility to Radio Frequency Interference.
- Use of AC solid state relays may according to the application and the load current, cause conducted radio interferences. Use of mains filters may be necessary for cases where the user must meet E.M.C requirements. The capacitor values given inside the filtering specification tables should be taken only as indications, the filter attenuation will depend on the final application.
- This product has been designed for Class A equipment. (External filtering may be required, refer to filtering section). Use of this product in domestic environments may cause radio interference, in which case the user may be required to employ additional mitigation methods.
- Surge tests on RGC..A models were carried out with the signal line impedance network. In case the line impedance is less than 40Ω, it is suggested that AC supply is provided through a secondary circuit where the short circuit limit between conductors and ground is 1500VA or less.
- A deviation of one step in the distributed full cycle models and up to 1.5% Full Scale Deviation in phase angle models is considered to be within PC1 criteria.

- Performance Criteria 1 (Performance Criteria A): No degradation of performance or loss of function is allowed when the product is operated as intended.
- Performance Criteria 2 (Performance Criteria B): During the test, degradation of performance or partial loss of function is allowed. However, when the test is complete the product should return operating as intended by itself.
- Performance Criteria 3 (Performance Criteria C): Temporary loss of function is allowed, provided the function can be restored by manual operation of the control.

Filtering - EN/IEC 55011 Compliance

Compliance to Class A emission limits

| | RGC1P..12 | RGC1P..30 | RGC1P..42 | RGC1P..50 | RGC1P..62 |
|-------------------------------------|--------------------------------|--------------------------|--|--------------------------|---|
| Max. Load Current | 15 AAC | 30 AAC | 43 AAC | 50 AAC | 60 AAC |
| | SCHURTER, 5500.2218 | SCHAFFNER, FN2410-45-33 | SCHAFFNER, FN2410-45-33 | SCHAFFNER, FN2410-60-34 | |
| Mode 1 - Phase Angle | ROXBURGH, RES90F16 RES90F20 | EPCOS, SIFI -H-G136 | A50R000 EPCOS, A42R122 SIFI-H-G136 (up to 36 AAC) | EPCOS, A50R000 | SCHAFFNER, FN2410-60-34 |
| Mode 2 -1x Full Cycle | 1.0uF, max. 760 VAC / X1 | 2.2uF, max. 760 VAC / X1 | 3.3uF, max. 760 VAC / X1 | 3.3uF, max. 760 VAC / X1 | 3.3uF, max. 760 VAC / X1 |
| Mode 3 - 4x Full Cycle | 680nF, max. 760 VAC / X1 | 1uF, max. 760 VAC / X1 | 2.2uF, max. 760 VAC / X1 | 2.2uF, max. 760 VAC / X1 | 2.2uF, max. 760 VAC / X1 |
| Mode 4 - 16x Full Cycle | 330nF, max. 760 VAC / X1 | 680nF, max. 760 VAC / X1 | 1uF, max. 760 VAC / X1 | 1uF, max. 760 VAC / X1 | 2.2uF, max. 760 VAC / X1 |
| Mode 5 - Advanced full cycle | 1.0uF, max. 760 VAC / X1 | 3.3uF, max. 760 VAC / X1 | 3.3uF, max. 760 VAC / X1 | 3.3uF, max. 760 VAC / X1 | SCHAFFNER, FN2410-60-34 EPCOS, A60R000 |
| Mode 6 - Soft start + Mode 4 | 330nF, max. 760 VAC / X1 | 680nF, max. 760 VAC / X1 | 1uF, max. 760 VAC / X1 | 1uF, max. 760 VAC / X1 | 2.2uF, max. 760 VAC / X1 |
| Mode 7 - Soft start + Mode 5 | 1.0uF, max. 760 VAC / X1 | 3.3uF, max. 760 VAC / X1 | 3.3uF, max. 760 VAC / X1 | 3.3uF, max. 760 VAC / X1 | SCHAFFNER, FN2410-60-34 EPCOS, A60R000 |

Compliance to Class B emission limits

| | RGC1P..12 | RGC1P..30 | RGC1P..42 | RGC1P..50 | RGC1P..62 |
|-------------------------------------|---|--------------------------|---|--|---|
| Max. Load Current | 15 AAC | 30 AAC 43 AAC | 50 AAC | 60 AAC | |
| | SCHURTER, 5500.2069 (up to 12 AAC) | | | | |
| Mode 1 - Phase Angle | SIFI-H-G120 EPCOS, B12R000 (up to 12 AAC) | EPCOS, A42R1122 | EPCOS, A55R122 | EPCOS, A55R122 | EPCOS, A75R122 |
| | | SCHAFFNER, FN2410-45-33 | SCHAFFNER, FN2410-45-33 | SCHAFFNER, FN2410-60-34 | SCHAFFNER, FN2410-60-34 |
| Mode 2 - 1x Full Cycle | 3.3uF, max. 760 VAC / X1 | EPCOS, SIFI-H-G136 | ROXBURGH, MDF50 A50R000 EPCOS, A42R122 SIFI-H-G136 (up to 36 AAC) | ROXBURGH, MDF50 A55R122 EPCOS, A42R122 (up to 42 AAC) | EPCOS, A60R000 |
| Mode 3 - 4x Full Cycle | 2.2uF, max. 760 VAC / X1 | 3.3uF, max. 760 VAC / X1 | 3.3uF, max. 760 VAC / X1 | SCHAFFNER, FN2410-60-34 A55R122 EPCOS, A42R122 (up to 42 AAC) | SCHAFFNER, FN2410-60-34 EPCOS, A60R000 |
| Mode 4 - 16x Full Cycle | 1.0uF, max. 760 VAC / X1 | 2.2uF, max. 760 VAC / X1 | 2.2uF, max. 760 VAC / X1 | 3.3uF, max. 760 VAC / X1 | 3.3uF, max. 760 VAC / X1 |
| | SCHURTER, 5500.2218 | SCHAFFNER, FN2410-45-33 | SCHAFFNER, FN2410-45-33 | SCHAFFNER, FN2410-60-34 | SCHAFFNER, FN2410-60-34 |
| Mode 5 - Advanced full cycle | ROXBURGH, RES90F16 RES90F20 | EPCOS, SIFI-H-G136 | ROXBURGH, MDF50 A50R000 EPCOS, A42R122 SIFI-H-G136 (up to 36 AAC) | ROXBURGH, MDF50 A55R122 EPCOS, A42R122 (up to 42 AAC) | EPCOS, A60R000 |
| Mode 6 - Soft start + Mode 4 | 1.0uF, max. 760 VAC / X1 | 2.2uF, max. 760 VAC / X1 | 2.2uF, max. 760 VAC / X1 | 3.3uF, max. 760 VAC / X1 | 3.3uF, max. 760 VAC / X1 |
| | SCHURTER, 5500.2218 | SCHAFFNER, FN2410-45-33 | SCHAFFNER, FN2410-45-33 | SCHAFFNER, FN2410-60-34 | SCHAFFNER, FN2410-60-34 |
| Mode 7 - Soft start + Mode 5 | ROXBURGH, RES90F16 RES90F20 | EPCOS, SIFI-H-G136 | ROXBURGH, MDF50 A50R000 EPCOS, A42R122 SIFI-H-G136 (up to 36 AAC) | ROXBURGH, MDF50 A55R122 EPCOS, A42R122 (up to 42 AAC) | EPCOS, A60R000 |

Filter Connection Diagram

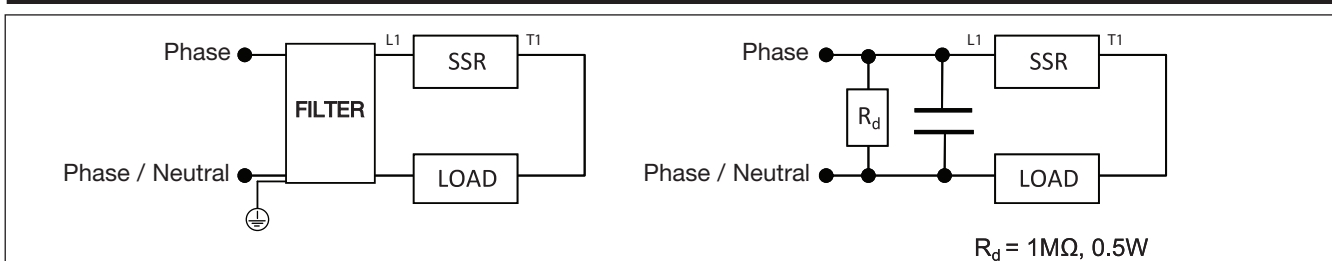

Note: The suggested filtering is determined by tests carried out on a representative setup and load. The RGC1P.. is intended to be integrated within a system where conditions may differentiate from conditions utilised for tests, such as load, cable lengths and other auxiliary components that may exist within the end system. It shall be the responsibility of the system integrator to ensure that the system containing the above component complies with the applicable rules and regulations.

Filter manufacturer installation recommendations shall be taken in consideration when utilising such filters.

Product Interface

RGC1P..AA..

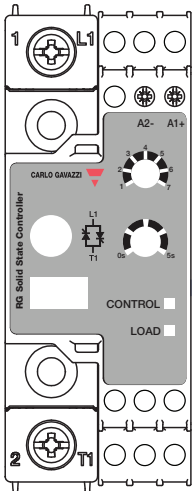

Terminals Labelling:

1/L1: Line connection
 2/T1: Load connection
 A1 - A2: Control input: 4 - 20 mA

RGC1P..V..

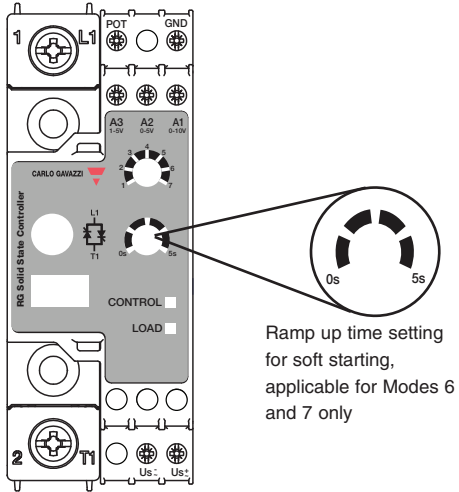

Terminals Labelling:

1/L1: Line connection
 2/T1: Load connection
 A1-GND: Control input: 0-10V
 A2-GND: Control input: 0-5V
 A3-GND: Control input: 1-5V
 POT: External potentiometer input
 Us (+, -): External supply, positive signal (RG..V.D) or AC signal (RG..V.A)
 Us (-, -): External supply, ground (RG..V.D) or AC signal (RG..V.A)

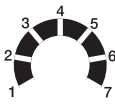
| Mode Selection | Switching Mode | |
|---|----------------|----------------------------------|
|  | 1 | Phase Angle (default setting) |
| | 2 | 1x Full Cycle |
| | 3 | 4x Full Cycles |
| | 4 | 16x Full Cycles |
| | 5 | Advanced Full Cycle |
| | 6 | Soft start + 16x Full Cycles |
| | 7 | Soft start + Advanced Full Cycle |

LED Indications

RGC1P..AA..

| LED | Status | Timing Diagram |
|-----------------|--------------------|----------------|
| CONTROL (green) | Control input <4mA | |
| | Control input >4mA | |
| | Mains loss | |
| | SSR internal error | |
| LOAD (yellow) | LOAD ON | |

RGC1P..V..

| LED | Status | Timing Diagram |
|-----------------|------------------------|----------------|
| CONTROL (green) | Supply voltage (Us) ON | |
| | Control input >0V | |
| | Mains loss | |
| | SSR internal error | |
| LOAD (yellow) | LOAD ON | |

Switching Modes

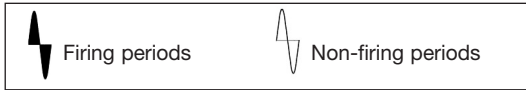

MODE 1: Phase angle switching

The Phase angle switching mode works in accordance with the phase angle control principle. The power delivered to the load is controlled by the firing of the thyristors over each half mains cycle. The firing angle depends on the input signal level that determines the output power to be delivered to the load.

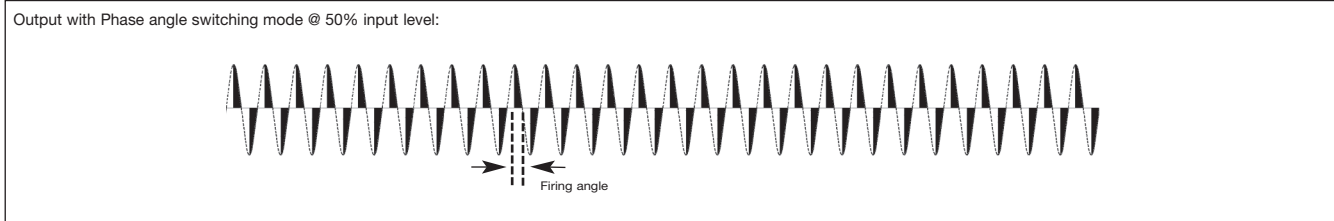

Full cycle switching

In Full cycle switching modes only full cycles are being switched. Switching at zero voltage reduces EMC interference as compared to phase angle switching (mode 1). The ON full cycles are distributed over a specific time base. Compared to burst firing, this enables faster and more accurate control of the load in addition to extending the heater lifetime. This mode is suitable for use only with resistive loads.

MODE 2: 1x Full cycle switching

This mode offers the lowest resolution for full cycle switching, i.e., 1 full cycle. At 50% output power demand the SSR will switch ON the load for 1 full cycle and OFF for 1 full cycle in a repeated pattern. Below 50% output power demand, the non-firing period increases but the firing period remains fixed at 1 full cycle. Over 50% output power demand, the firing period increases but the non-firing period remains fixed at 1 full cycle.

Hence at 25% output power demand, the non-firing period gets longer and the SSR will switch ON the load for 1 full cycle and OFF for 3 full cycles in a repeated pattern. At 75% output power demand, the firing period is longer and the SSR will switch ON the load for 3 full cycles and OFF for 1 full cycle in a repeated pattern. At 100% output power demand, the SSR switches the load fully ON.

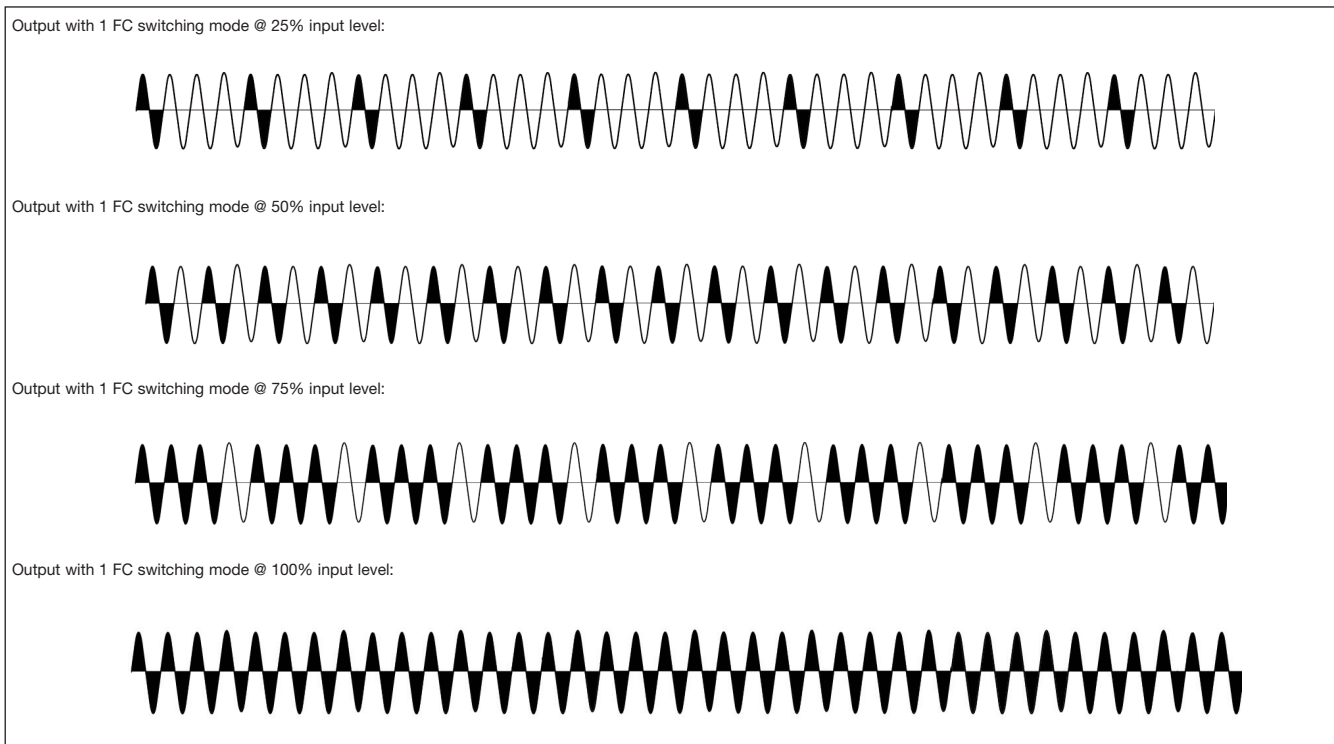

Switching Modes

MODE 3: 4x Full cycle switching

MODE 4: 16x Full cycle switching

In **mode 3** the minimum resolution is 4 full cycles. At 50% output power demand the SSR will switch ON the load for 4 full cycles and OFF for 4 full cycles in a repeated pattern. Below 50% output power demand, the non-firing period increases but the firing period remains fixed at 4 full cycles. Over 50% output power demand, the firing period increases but the non-firing period remains fixed at 4 full cycles.

In **mode 4** the minimum resolution is 16 full cycles. At 50% output power demand the SSR will switch ON the load for 16 full cycles and OFF for 16 full cycles in a repeated pattern. Below 50% output power demand, the non-firing period increase but the firing period remains fixed at 16 full cycles. Over 50% output power demand the firing period increases but the non-firing period remains fixed at 16 full cycles.

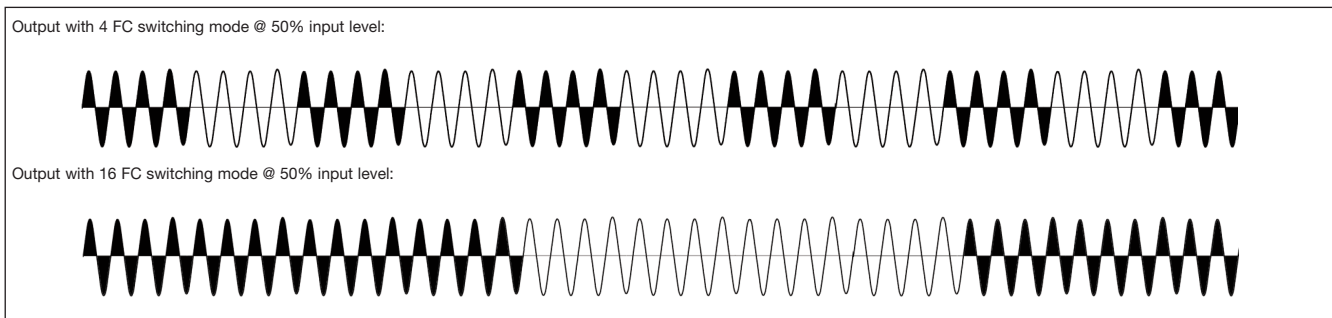

MODE 5: Advanced Full Cycle (AFC) switching

This switching mode is based on the principle of distributed full cycle explained above with the difference that the resolution for firing and non-firing periods is changed to a half mains cycle. This mode is intended for use with short / medium wave infrared heaters. The purpose of the half cycle non-firing time is to reduce the annoying visual flickering of such lamp loads.

Below 50% output power demand, the SSR switches ON the load in half cycle periods. The non-firing periods are full cycles.
Above 50% output power demand, the SSR switches ON the load in full cycle periods but the non-firing periods are half cycles.



SOFT STARTING

Soft starting is utilised to reduce the start-up current of loads having a high cold to hot resistance ratio such as short wave infrared heaters. The thyristor firing angle is gradually increased over a time period of maximum 5 seconds (settable through an accessible potentiometer) in order to apply the voltage (and current) to the load smoothly.

Soft starting is performed on the first power up and in cases of non firing periods exceeding 5 seconds. If soft start is stopped before soft start completion, it is assumed that a start was performed and the non firing period count start as soon as the soft start is stopped.

Switching Modes

MODE 6: Soft start + MODE 4 (16x full cycle switching)

This switching mode works on the principle of switching mode 4 (16x full cycles) but soft starting is performed on power up or in case of the non firing periods exceeding 5 seconds. After the soft start is completed, full cycles (with a resolution of 16 full cycles) are delivered to the load according to the input signal, based on MODE 4 switching principle.

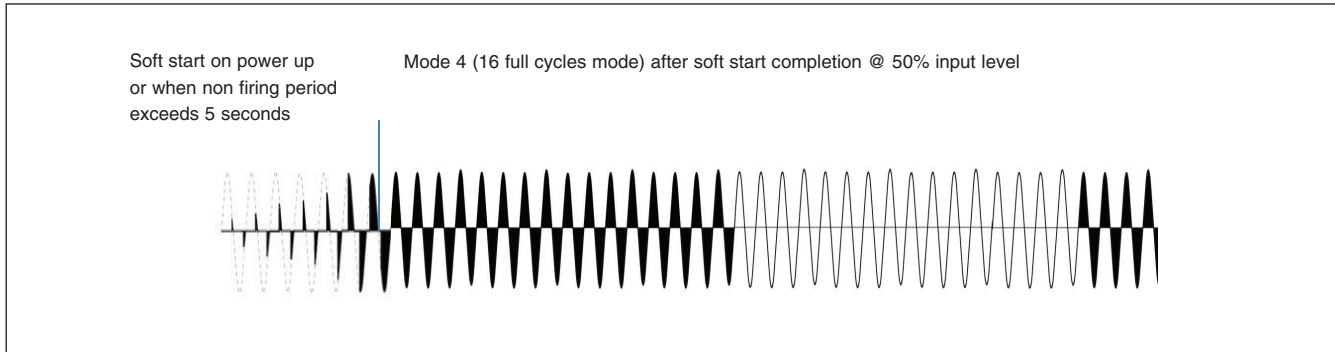

MODE 7: Soft start + MODE 5 (Advanced full cycle switching)

This switching mode works on the principle of the advanced full cycle (mode 5) but soft starting is performed on power up or in case of the non firing periods exceeding 5 seconds. After the soft start is completed, output power is delivered to the load according to the input signal, based on Mode 5 switching principle.

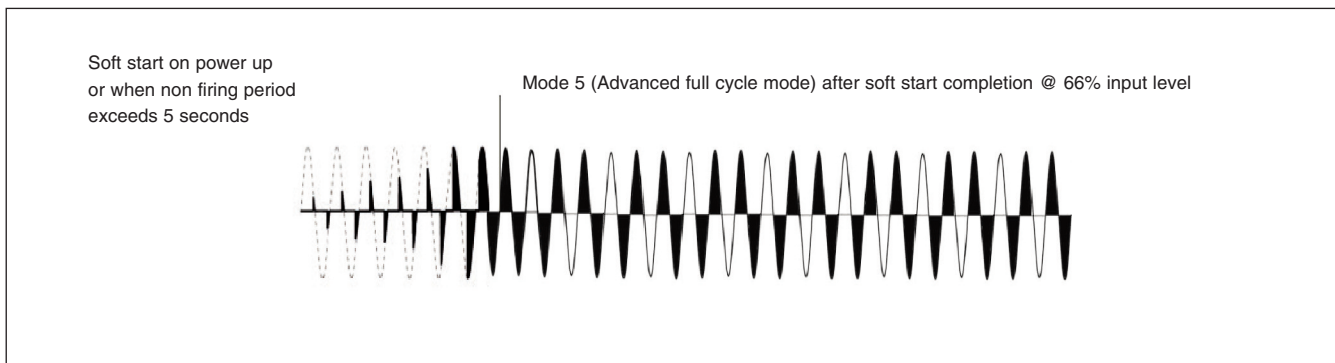

Dimensions

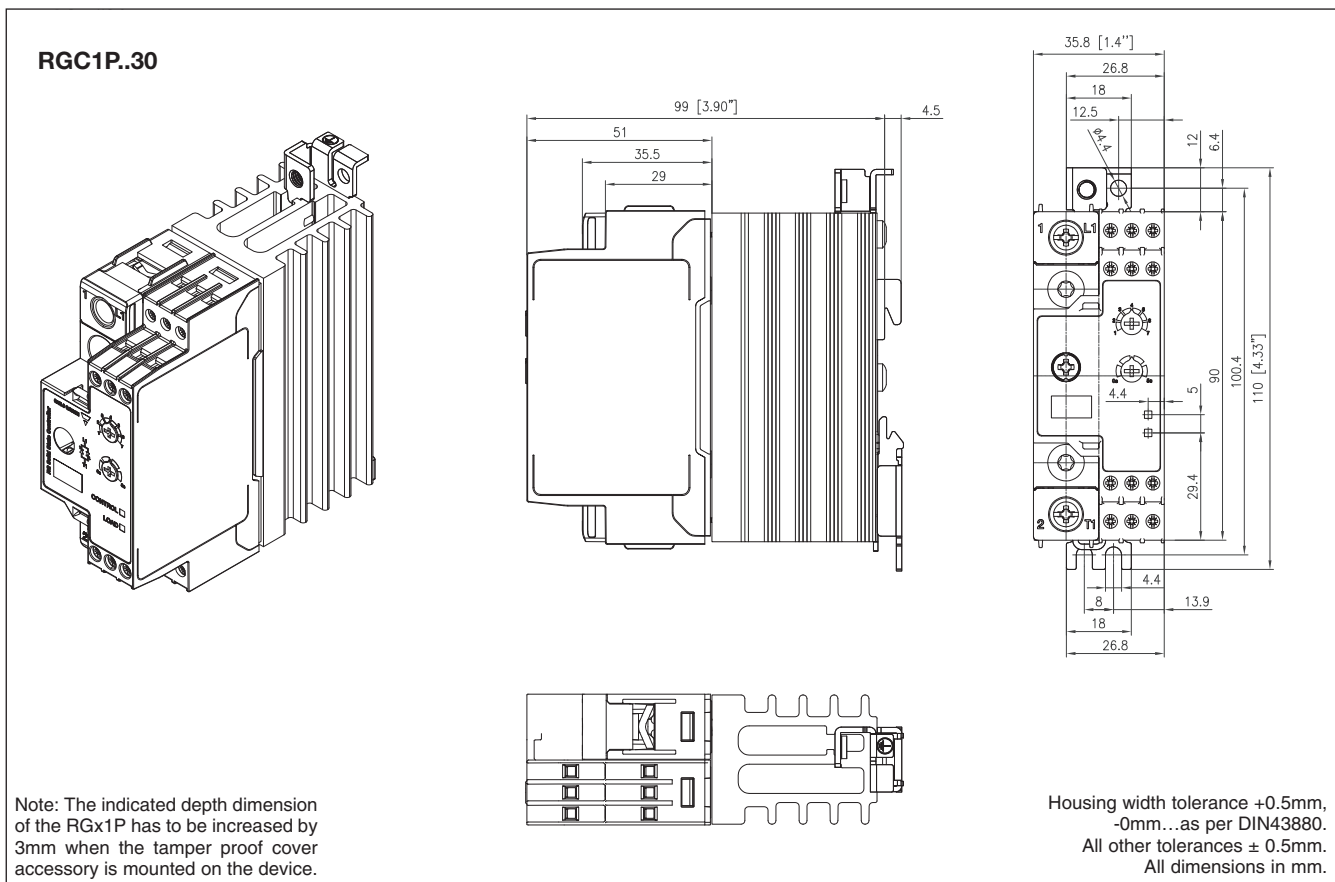
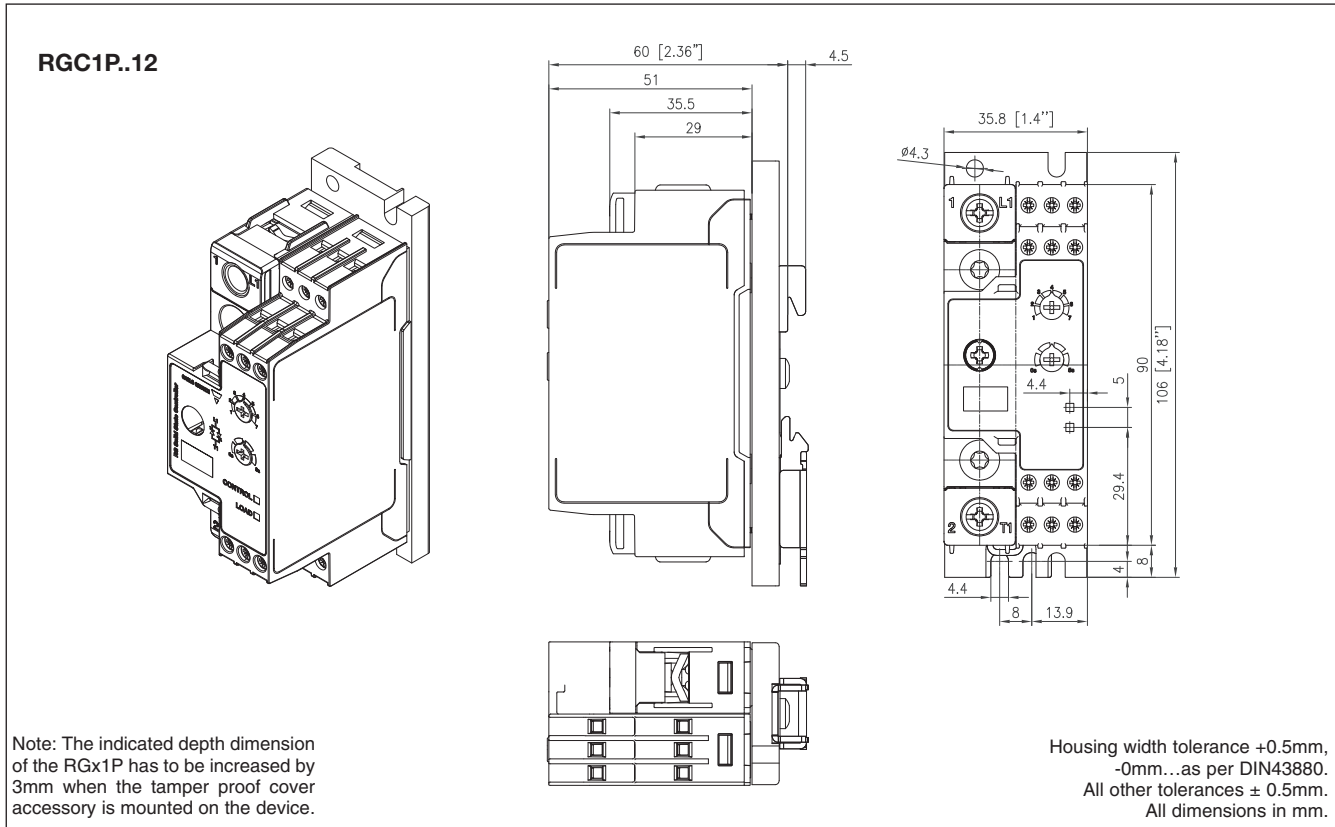

Dimensions

RGC1P..42

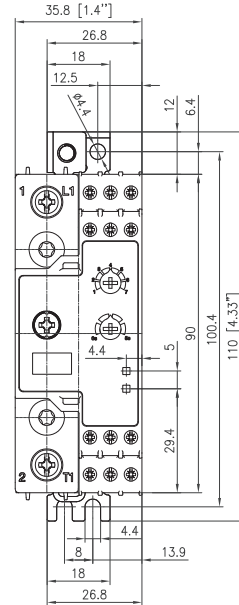
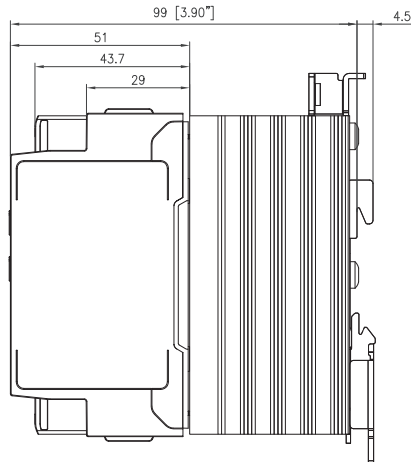
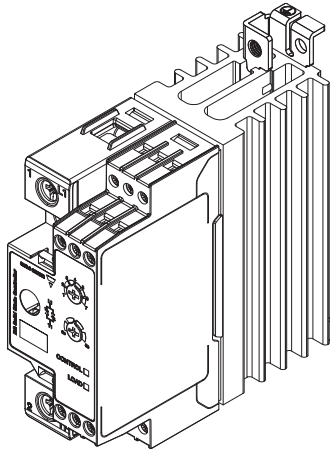

Note: The indicated depth dimension of the RGx1P has to be increased by 3mm when the tamper proof cover accessory is mounted on the device.

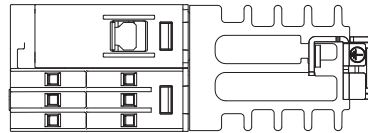

Housing width tolerance +0.5mm, -0mm...as per DIN43880. All other tolerances ± 0.5mm. All dimensions in mm.

RGC1P..50 RGC1P..62

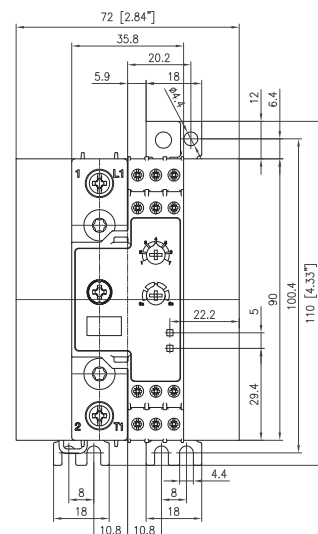
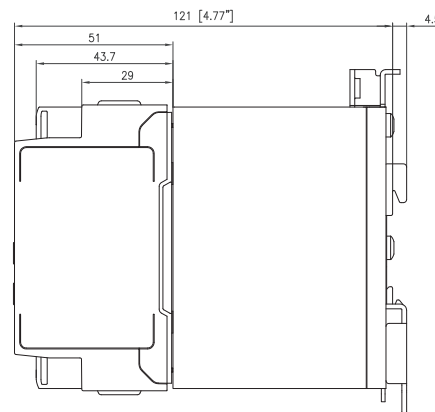
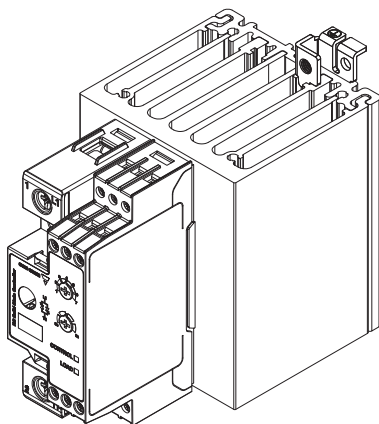



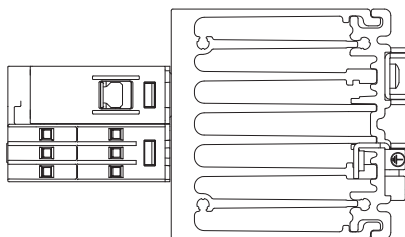



Note: The indicated depth dimension of the RGx1P has to be increased by 3mm when the tamper proof cover accessory is mounted on the device.

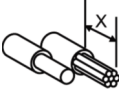

Housing width tolerance +0.5mm, -0mm...as per DIN43880. All other tolerances ± 0.5mm. All dimensions in mm.

Connection Specifications

| POWER CONNECTIONS | | 1/L1, 2/T1 | | |
|---|---|--|--|---|
| Use 75°C copper (Cu) conductors | | RGC..12, RGC..30 | | RGC..42, RGC..50, RGC..62 |
| Stripping length (X) | | 12mm  |  | 11mm  |
| Connection type | | M4 screw with captivated washer | | M5 screw with box clamp |
| Rigid (solid & stranded) UL/cUL rated data |  | 2x 2.5 - 6.0 mm ² 2x 14 - 10 AWG | 1x 2.5 - 6.0 mm ² 1x 14 - 10 AWG | 1x 2.5 - 25 mm ² 1x 14 - 3 AWG |
| Flexible with end sleeve |  | 2x 1.0 - 2.5 mm ² 2x 2.5 - 4.0 mm ² 2x 18 - 14 AWG 2x 14 - 12 AWG | 1x 1.0 - 4.0 mm ² 1x 18 - 12 AWG | 1x 2.5 - 16 mm ² 1x 14 - 6 AWG |
| Flexible without end sleeve |  | 2x 1.0 - 2.5 mm ² 2x 2.5 - 6.0 mm ² 2x 18 - 14 AWG 2x 14 - 10 AWG | 1x 1.0 - 6.0 mm ² 1x 18 - 10 AWG | 1x 4.0 - 25 mm ² 1x 12 - 3 AWG |
| Torque specification |  | Pozidriv 2 UL: 2Nm (17.7 lb-in) IEC: 1.5-2.0Nm (13.3-17.7 lb-in) | | Pozidriv 2 UL: 2.5Nm (22 lb-in) IEC: 2.5-3.0Nm (22-26.6 lb-in) |
| Aperture for termination lug | | 12.3mm | | n/a |



Protective Earth (PE) connection   M5, 1.5Nm (13.3 lb-in)
Not provided with SSR. PE connection required when product is intended to be used in Class 1 applications according to EN/IEC 61140

CONTROL CONNECTIONS

Use 60/ 75°C copper (Cu) conductors

GND, A1, A2, A3, POT, Us

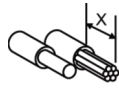

| | | |
|---|---|---|
| Stripping length (X) | | 8 mm |
| Connection type | | M3 screw with box clamp |
| Rigid (solid & stranded) UL/cUL rated data |  | 1x 1.0 - 2.5 mm ² 1x 18 - 12 AWG |
| Flexible with end sleeve |  | 1x 0.5 - 2.5 mm ² 1x 20 - 12 AWG |
| Torque specification |  | Pozidriv 1 UL: 0.5Nm (4.4 lb-in) IEC: 0.4-0.5Nm (3.5-4.4 lb-in) |

Connection Diagram

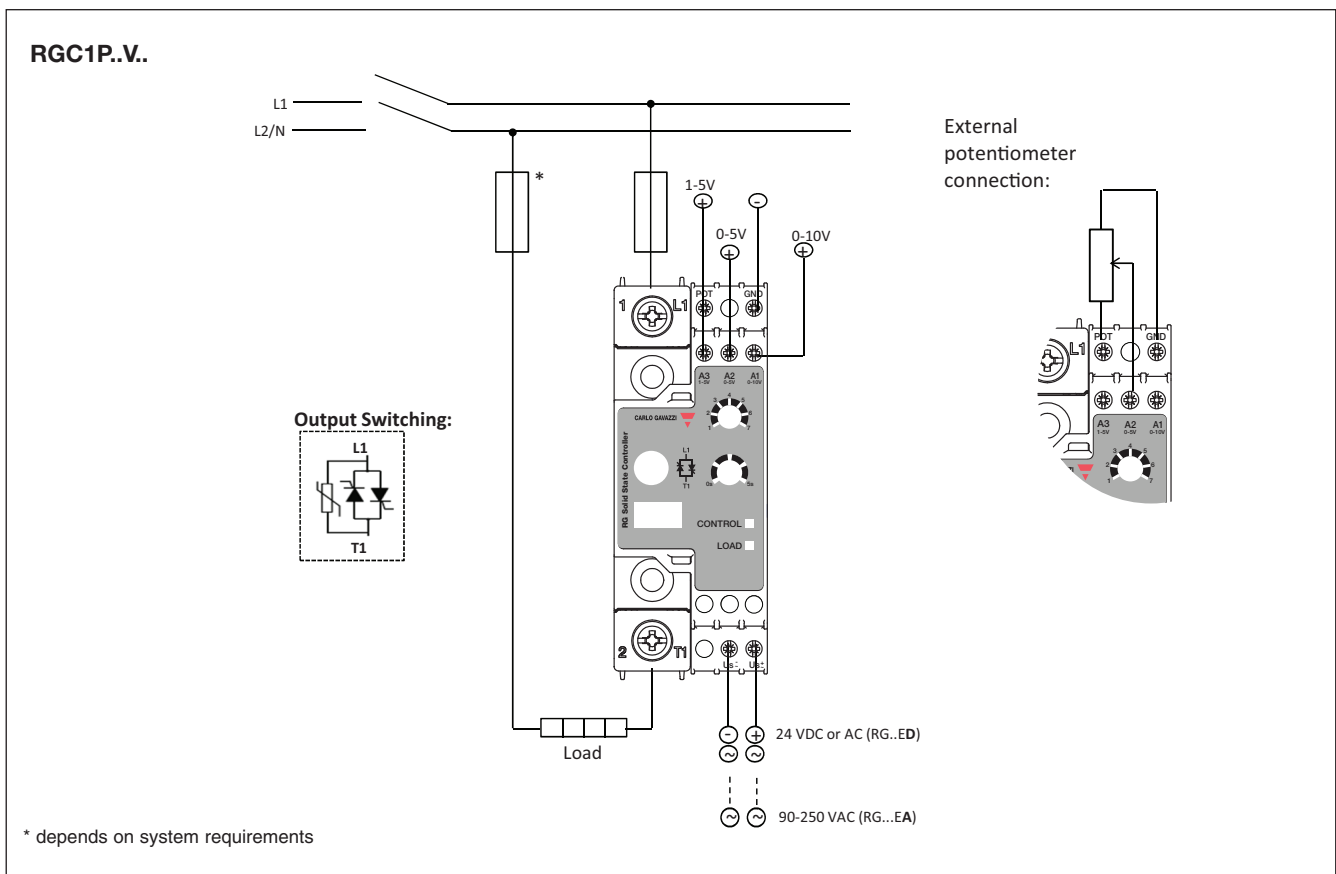
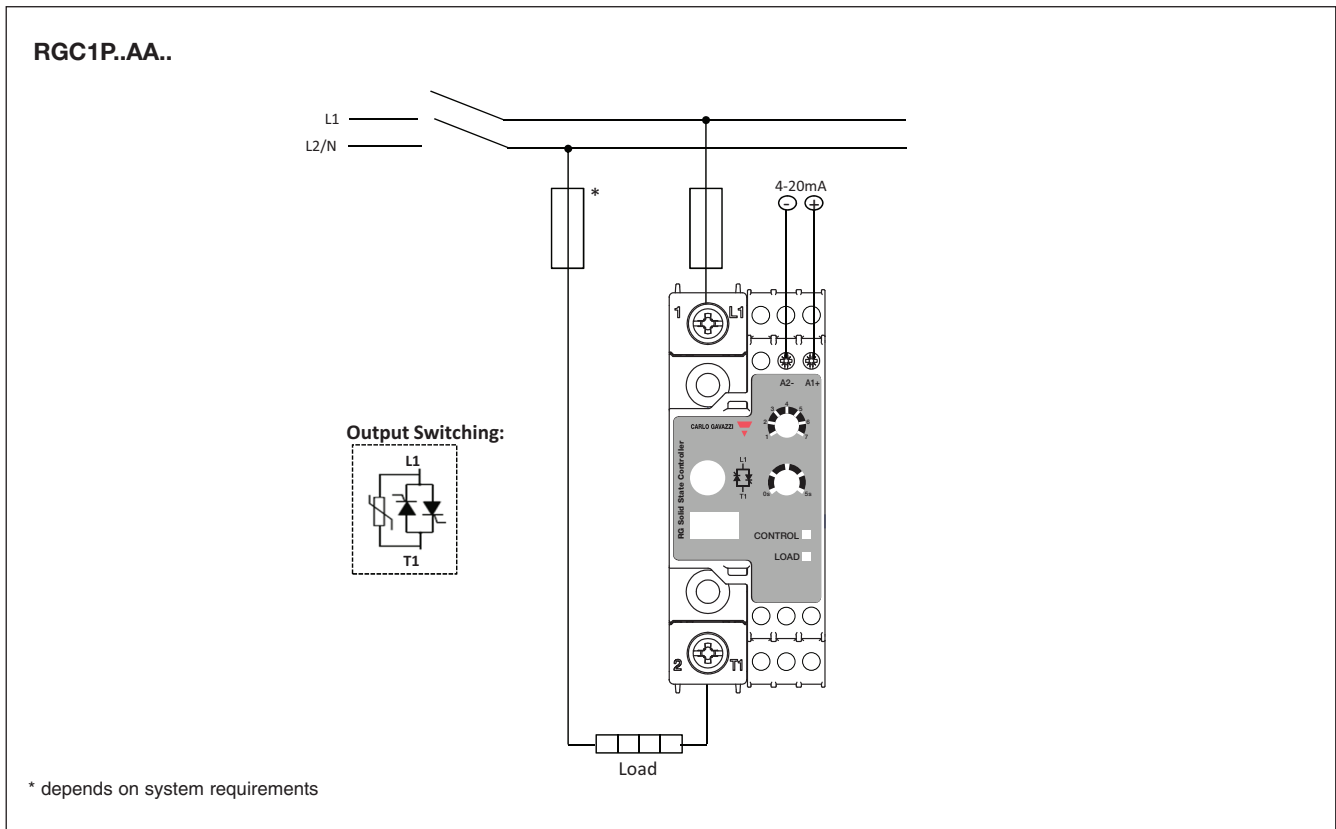

Mounting Instructions

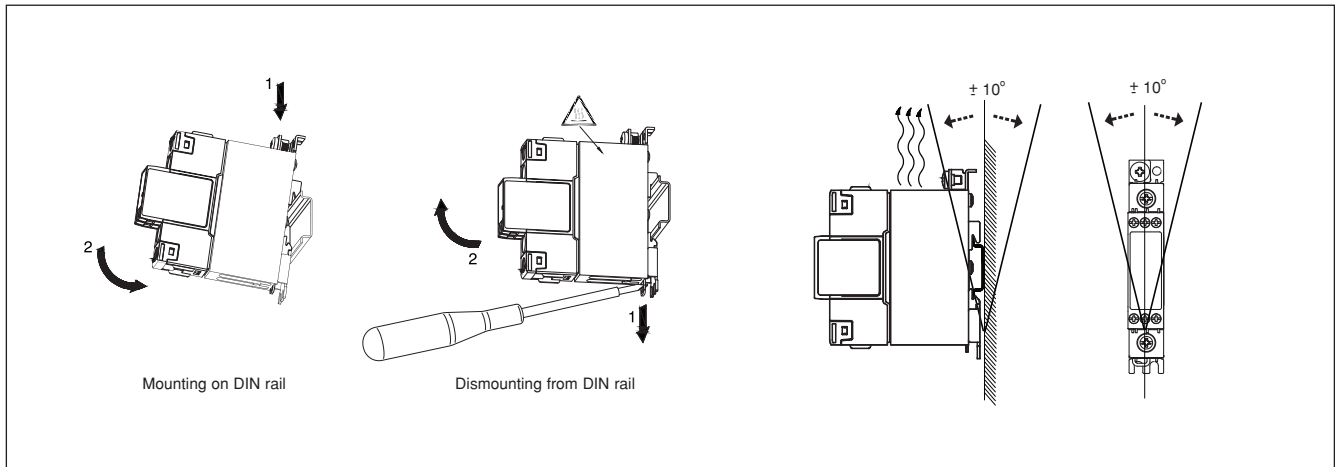

Installation Instructions

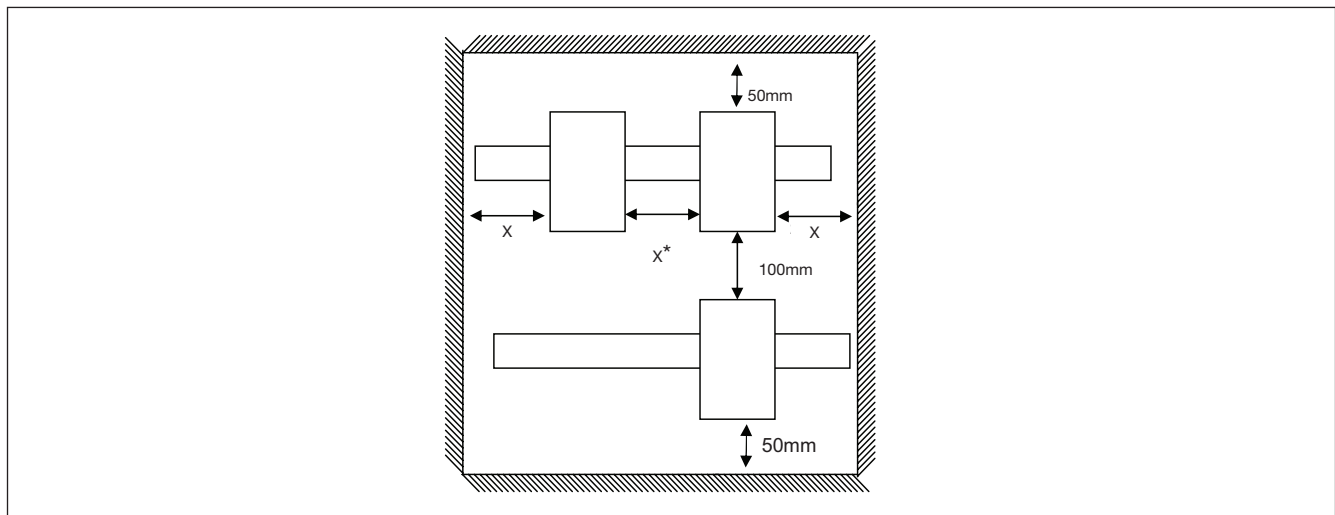

* Refer to Current Derating vs spacing curves. Spacing between SSR and panel walls should be >5mm.

Short Circuit Protection

Protection Co-ordination, Type 1 vs Type 2:

Type 1 protection implies that after a short circuit, the device under test will no longer be in a functioning state. In type 2 co-ordination the device under test will still be functional after the short circuit. In both cases, however the short circuit has to be interrupted. The fuse between enclosure and supply shall not open. The door or cover of the enclosure shall not be blown open. There shall be no damage to conductors or terminals and the conductors shall not separate from terminals. There shall be no breakage or cracking of insulating bases to the extent that the integrity of the mounting of live parts is impaired. Discharge of parts or any risk of fire shall not occur.

The product variants listed in the table hereunder are suitable for use on a circuit capable of delivering not more than 100,000A Symmetrical Amperes, 600Volts maximum when protected by fuses. Tests at 100,000Arms were performed with Class J fuses, fast acting; please refer to the tables below for maximum ratings. Tests with Class J fuses are representative of Class CC fuses.

Co-ordination type 1 (UL508)

| Part No. | Short circuit current [kArms] | Max. fuse size [A] | Class | Voltage [VAC] |
|-----------|-------------------------------|--------------------|---------|---------------|
| RGC1P..12 | 100 | 30 | J or CC | Max. 600 |
| RGC1P..30 | 100 | 30 | J or CC | Max. 600 |
| RGC1P..42 | 100 | 80 | J | Max. 600 |
| RGC1P..50 | 100 | 30 | J | Max. 600 |
| RGC1P..62 | 100 | 80 | J | Max. 600 |

Co-ordination type 2 (EN/IEC 60947-4-3)

| Part No. | Short circuit current [kArms] | Ferraz Shawmut (Mersen) | | Siba | | Voltage [VAC] |
|------------------------|-------------------------------|-------------------------|--------------------------|--------------------|---------------|---------------|
| | | Max. fuse size [A] | Part No. | Max. fuse size [A] | Part No. | |
| RGC1P..12 RGC1P..30 | 10 | 40 | 6.9xx CP GRC 22x58 /40 | 32 | 50 142 06.32 | Max. 600 |
| | 100 | 40 | 6.9xx CP URD 22x58 /40 | 32 | 50 142 06.32 | Max. 600 |
| RGC1P..42 | 10 | 63 | 6.9xx CP URC 14x51 /63 | 80 | 50 142 20.80 | Max. 600 |
| | 10 | 70 | A70QS70-4 | 80 | 50 142 20.80 | Max. 600 |
| | 100 | 63 | 6.9xx CP URC 14x51 /63 | 80 | 50 142 20.80 | Max. 600 |
| | 100 | 70 | A70QS70-4 | 80 | 50 142 20.80 | Max. 600 |
| RGC1P..50 | 10 | 80 | 6.621 CP URQ 27x60 /80 | 80 | 50 142 20.80 | Max. 600 |
| | 100 | n/a | n/a | 80 | 50 142 20.80 | Max. 600 |
| RGC1P..62 | 10 | 100 | 6.9xx CP GRC 22x58 /100 | 100 | 50 142 20.100 | Max. 600 |
| | 10 | 100 | A70QS100-4 | 100 | 50 142 20.100 | Max. 600 |
| | 100 | 100 | 6.621 CP URGD 27x60 /100 | 100 | 50 142 20.100 | Max. 600 |
| | 100 | 100 | A70QS100-4 | 100 | 50 142 20.100 | Max. 600 |

xx = 00, without fuse trip indication

xx = 21, with fuse trip indication

Type 2 Protection with Miniature Circuit Breakers (M.C.B.s)

| Solid State Relay type | ABB Model no. for Z - type M. C. B. (rated current) | ABB Model no. for B - type M. C. B. (rated current) | Wire cross sectional area [mm ²] | Minimum length of Cu wire conductor [m] ¹⁰ | |
|---|---|---|--|---|----------------------------|
| RGC1P.12 RGC1P.30 (1800 A ² s) | 1 pole | | | | |
| | S201 - Z10 (10A) | S201-B4 (4A) | 1.0 1.5 2.5 | 7.6 11.4 19.0 | |
| | S201 - Z16 (16A) | S201-B6 (6A) | 1.0 1.5 2.5 4.0 | 5.2 7.8 13.0 20.8 | |
| | S201 - Z20 (20A) | S201-B10 (10A) | 1.5 2.5 | 12.6 21.0 | |
| | S201 - Z25 (25A) | S201-B13 (13A) | 2.5 4.0 | 25.0 40.0 | |
| | 2 pole | | | | |
| | S202 - Z25 (25A) | S202-B13 (13A) | 2.5 4.0 | 19.0 30.4 | |
| | RGC1P.50 (3200 A ² s) | 1 pole | | | |
| | | S201 - Z25 (25A) | S201-B13 (13A) | 2.5 4.0 6.0 | 7.0 11.2 16.8 |
| | | RGC1P.42 RGC1P.62 (18000 A ² s) | 1 pole | | |
| | S201-Z32 (32A) | | S201-B16 (16A) | 2.5 4.0 6.0 | 3.0 4.8 7.2 |
| | S201-Z50 (50A) | | S201-B25 (25A) | 4.0 6.0 10.0 16.0 | 4.8 7.2 12.0 19.2 |
| | S201-Z63 (63A) | | S201-B32 (32A) | 6.0 10.0 16.0 | 7.2 12.0 19.2 |

10. Between MCB and Load (including return path which goes back to the mains).

Note: A prospective current of 6kA and a 230/400V power supply system is assumed for the above suggested specifications. For cables with different cross section than those mentioned above please consult Carlo Gavazzi's Technical Support Group.

Environmental Information

The declaration in this section is prepared in compliance with People's Republic of China Electronic Industry Standard SJ/T11364-2014: Marking for the Restricted Use of Hazardous Substances in Electronic and Electrical Products.

| Part Name | Toxic or Harardous Substances and Elements | | | | | |
|---------------------|--|--------------|--------------|------------------------------|--------------------------------|---------------------------------------|
| | Lead (Pb) | Mercury (Hg) | Cadmium (Cd) | Hexavalent Chromium (Cr(VI)) | Polybrominated biphenyls (PBB) | Polybrominated diphenyl ethers (PBDE) |
| Power Unit Assembly | x | ○ | ○ | ○ | ○ | ○ |

O: Indicates that said hazardous substance contained in homogeneous materials for this part are below the limit requirement of GB/T 26572.

X: Indicates that said hazardous substance contained in one of the homogeneous materials used for this part is above the limit requirement of GB/T 26572.

环境特性

这份申明根据中华人民共和国电子工业标准 SJ/T11364-2014：标注在电子电气产品中限定使用的有害物质

| 零件名称 | 有毒或有害物质与元素 | | | | | |
|------|------------|--------|--------|--------------|-------------|--------------|
| | 铅 (Pb) | 汞 (Hg) | 镉 (Cd) | 六价铬 (Cr(VI)) | 多溴化联苯 (PBB) | 多溴联苯醚 (PBDE) |
| 功率单元 | x | ○ | ○ | ○ | ○ | ○ |

O:此零件所有材料中含有的该有害物低于GB/T 26572的限定。

X: 此零件某种材料中含有的该有害物高于GB/T 26572的限定。



Accessories

Tamper Proof Accessory Kit



Ordering Key

Tamper proof accessory kit for RGS1P, RGC1P series containing:

- x5 transparent covers
- x5 securance ties

RGTMP

Tamper proof cover & securance tie included in packaging. Refer to instructions below for mounting to the Solid State Relay.

RGC1P...T

Installation

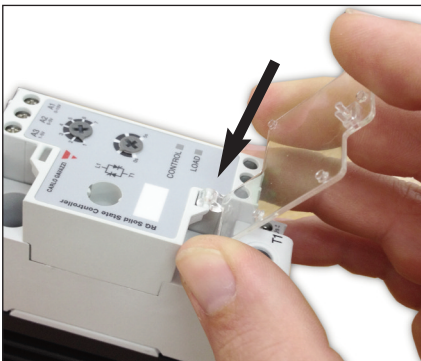

1: Clip hook of the transparent cover to the bottom loop of the RGx1P control module

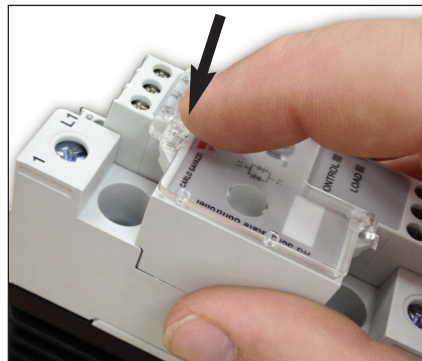

2: Close the cover by clipping to the top loop of the RGx1P control module

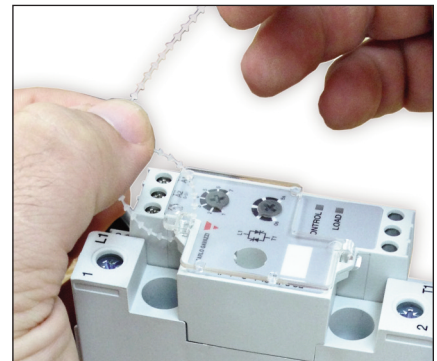

3: Secure with provided tie